

Operating instructions

Laboratory mortar mixer

Model 1.0203

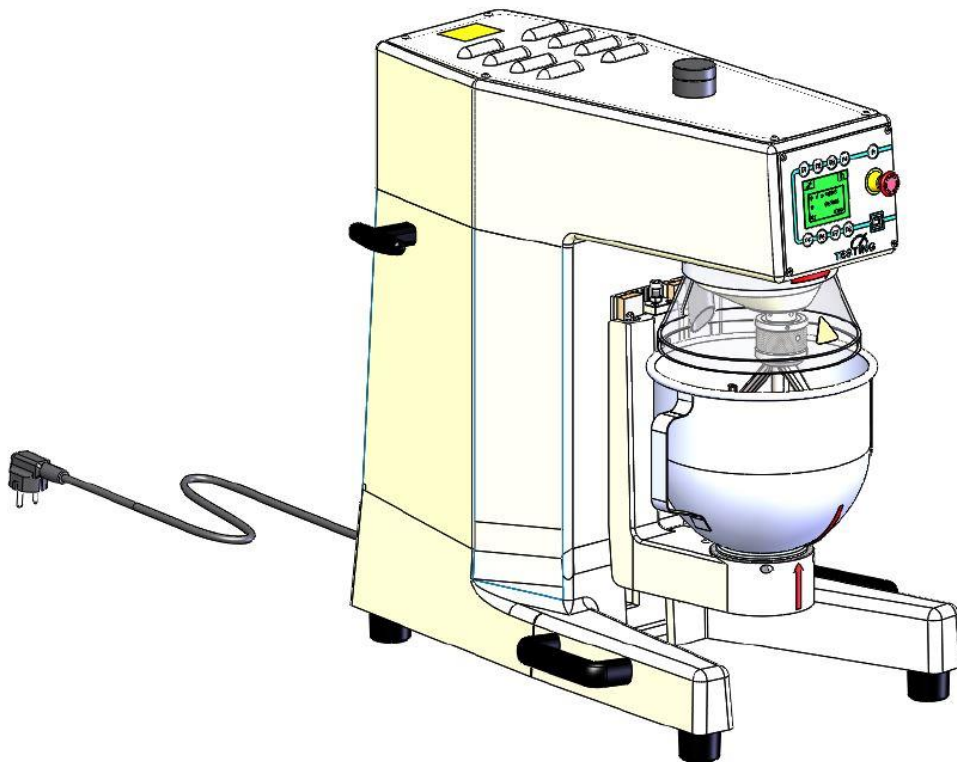

Importance of the operating instructions

Before operating the laboratory mortar mixer, the operating instructions must be read and understood.

Contents	Page
1. Reception, transport	5
1.1 Reception	5
1.2 Transport	5
1.3 Removing the transport packaging	5
1.4 Transport by hand	6
2. Scope of delivery	6
3. Basic safety instructions	7
3.1 Obligations of the operator	7
3.2 Requirements for the operating personnel	7
3.3 Obligations of the operating personnel	7
3.4 Workplace	7
3.5 Danger when handling the mortar mixer	8
4. Basic notes	8
4.1 Intended use	8
4.2 Improper use	10
4.3 Information on the CE symbol	10
4.4 Obligation of the operator	10
4.5 General safety instructions	11
4.6 Protective clothing	13
4.7 Periodic inspection	13
5. Description of the mortar mixer	13
5.1 Mechanical design	13
5.2 Electrical design	14
5.3 Safety devices	15
6. Preparations for commissioning	16
6.1 Installation location/ambient conditions	16
6.2 Electrical connection	16
6.3 Lowering and removing the mixing bowl	17
6.4 Loosening and removing the mixer	17
6.5 Inserting and tightening the mixer	17
6.6 Inserting and tightening the mixing bowl	17
6.7 Placing the mixing bowl in the mixing position	17
6.8 Adjusting the distance between the mixing bowl and mixer	18
7. Technical details	19
8. Operation	20
8.1 Switching on the mortar mixer	20
8.2 Explanation of the control unit	21
8.3 Key symbol	22
8.4 Start conditions	23
8.5 Basic settings in the service menu	23



8.6	Setting the language	26
8.7	Setting the display brightness	27
8.8	Setting the soft start	28
8.9	Selection of standardized or variable speed (optional).....	28
8.9.1	Setting the variable speeds.....	29
8.9.2	Working with the variable speeds	29
8.9.3	Finish working with the variable speeds	30
8.9.4	Setting the normalized speeds.....	30
8.10	Setting the signal.....	30
8.11	Lowering or removing the mixing trough during the pause.....	31
9.	Starting the mortar mixer.....	32
9.1.	Selecting/stopping low speed.....	33
9.2.	Selecting/stopping high speed	33
9.3.	Selecting pause.....	34
10.	Error messages in the display	36
11.	Switching off the mortar mixer	37
12.	Warranty	37
13.	Issue date of the operating instructions	37
14.	Copyright.....	38
15.	Address of the manufacturer	38
16.	Cleaning and maintenance	38
16.1	Cleaning the mortar mixer	38
16.2	Maintenance of the mortar mixer.....	39
16.3	Control and adjustment	39
16.4	Decommissioning the mortar mixer	39
17.	Spare parts - supply and customer service.....	40
18.	Scrapping, disposal.....	40
19.	I/O board	41
20.	Scircuit diagram.....	42

Annex documents:

Test protocol mechanics

Test and measurement record for the electrical system

The notes have the following meaning:

<p>Caution</p> 	<p>This warning applies to all procedures that must be carried out with caution in order to avoid damage to the device.</p>
<p>Danger</p> 	<p>This warning applies to all procedures that pose a risk to the operator if the procedures are not carried out with caution.</p>
<p>Note</p> 	<p>Provides practical information on operation</p>

1. Reception, transport

1.1 Reception

Check the visible external condition of the delivered shipment. If the condition is correct, the shipment can be accepted by the carrier (parcel service or freight forwarder).

If there is no objection or any transport damages detected, the completeness of the shipment must be checked against the delivery note.

If any transport damages occur after a successful acceptance, a production log with an exact report and a photo about the extent of the damage must be immediately prepared. Please send us the production log immediately by fax. Absolutely no changes may be made to the delivered shipment.

On the basis of this production log, we should be able to assess whether the damage can be remedied

- by the delivery of spare parts or
- by sending a skilled technician or only
- by returning the device.

1.2 Transport

The mortar mixer is supplied in suitable cardboard packaging, standing on a pallet.

The weight of the mortar mixer is approx. 58 kg.



The mortar mixer can be moved to its intended location in the delivery packaging, by means of a pallet truck or other suitable floor-level conveyors that must be able to reach under the pallet.

Wrapping with ropes or similar lifting gear is only permissible if it is ensured that no lateral forces are exerted on the packaging and therefore also possibly on parts of the mortar mixer.

1.3 Removing the transport packaging

To remove the transport packaging, proceed as follows:

- Open the lid of the transport packaging
- Remove the cardboard or polystyrene transport protection (inserts)
- Side panels should be cut open at the vertical edges
- Cut side panels at the horizontal bottom edges

<p>Danger</p> 	<p>The packaging materials (plastic, polystyrene, screws, nails, wood, etc.) must be kept away from children. They must be disposed of properly.</p>
<p>Caution</p> 	<p>Before you dispose of the packaging, please check if accessories, instructions, documents and spare parts remain inside the packaging.</p>

After unpacking the device, make sure that the mortar mixer has not been damaged in any obvious way during transport. If in doubt, do **not** plug in the device and contact your seller.

1.4 Transport by hand

The mortar mixer can be transported to its intended destination by hand. Its weight is about 58 kg.

To lift the mortar mixer, the lower handles, which are attached to the side of the load centre, are designed for a 40 kg load capacity. Lateral T-handles attached on the upper rear area serve to stabilise the load during carrying.

If taken by hand, the mortar mixer can be conveniently transported to its final location and set down.

The handles are exclusively used for transporting the mortar mixer by hand. They are not attachments to be used for transport by lifting equipment.

2. Scope of delivery

Pos.	Amount	Description	Serial number
1.	1	Mortar mixer (including operating instructions)	1.0203
2.	1	Stainless steel stirrer	1.0203.02EN
3.	1	Stainless steel bowl	1.0203.03EN
4.	1	Feed hopper for liquid or powder aggregates	8.0144

3. Basic safety instructions

3.1 Obligations of the operator

The operating instructions are to be kept in the immediate vicinity of the mortar mixer. Only suitably qualified operating personnel may work with the mortar mixer. The operating personnel must be trained before using the mortar mixer. Check that the operating personnel have read and understood the operating instructions. Establish exact responsibilities for the operating personnel. Personal protective equipment must be provided to all operating personnel.

The operator must take care not to put themselves or anyone else in danger.

If the operational safety is compromised due to defects or damage to the mortar mixer, the mortar mixer must be taken out of operation immediately and must only be used again after all potential hazards have been eliminated.

3.2 Requirements for the operating personnel

The mortar mixer may only be operated by suitably qualified specialist personnel who have been assigned and trained by the operator. The minimum age for the operator is 18 years. Under 18 years of age, the mortar mixer may only be operated under the supervision of a qualified specialist. The operator is responsible for the work area of third parties.

3.3 Obligations of the operating personnel

Before handling the mortar mixer, read the operating instructions carefully. Please observe the safety regulations. When handling the mortar mixer, personal protective equipment must be worn.

3.4 Workplace

The workplace is located on the control panel in front of the mortar mixer. The workplace is determined by the customer-connected peripherals. It must therefore be designed by the operator in order to be safe. The design of the workplace also depends on the applicable requirements of the BetrSichV (Industrial Safety Regulation) and the risk analysis of the workplace.

3.5 Danger when handling the mortar mixer

The mortar mixer is built according to state-of-the-art and recognised technical rules. Nevertheless, danger to the user's life or that of third parties or damage to machine parts or other property may occur during its use.

The mortar mixer is only to be used

- for the intended use
- and in a flawless condition in terms of safety.

Any faults that may affect safety must be immediately resolved.

4. Basic notes

4.1 Intended use

This description contains the necessary information for the intended use of the products described therein. It is intended for technically qualified personnel. The operator must clearly establish the area of responsibility of their personnel.

Qualified personnel are persons who have been authorised by the person responsible for the safety of the machine to carry out the necessary activities due to their training, experience, instruction and knowledge of relevant standards, regulations, accident prevention regulations and operating conditions, thereby being able to recognise and avoid possible dangers (Definition for qualified specialist according to IEC 364).

The requirements and limit values stated in these operating instructions, as well as the safety instructions provided, must be complied with. Any use beyond this scope shall be considered to be an intentional misuse. If special work practices or conditions are required, the manufacturer's consultation and approval should be acquired.

The manufacturer accepts no liability for damages caused as a result of a failure to observe these "safety and operating instructions".

The mortar mixer is used exclusively for the mechanical mixing of mortars and cement paste for the production of test specimens according to different standards.

Intended use includes the following applications:

- **MANUAL** - Operation with selectable mixing speeds
The requirements and limit values, as well as the safety instructions provided in these operating instructions, must be complied with in all cases.

<p>Note</p> 	<p>The mortar mixer is designed for operation in dry spaces.</p>
---	--

Any use beyond this scope shall be considered to be an intentional misuse. If special work practices or conditions are required, the manufacturer's consultation and approval should be acquired.

<p>Note</p> 	<p>The operating instructions indicated in these instructions only apply to the correct use of the mortar mixer. In order to perform the operation correctly, the user must observe the specific standards for the test.</p>
---	--

- These operating instructions are intended for the forwarding agent, the installer, the operator, the maintenance technician and the disposal company.
- Please read these instructions carefully, because they describe how the mortar mixer is safe to operate.
- These operating instructions shall be considered to be part of the product and only apply to the mortar mixer that they are supplied with.
- Keep the operating instructions in a suitable condition throughout the entire operating period, so that they can be consulted if necessary.
- If the mortar mixer is to be sold, the operating instructions and the attachments must be handed over with it.
- The manufacturer assumes no liability for any damage caused resulting from an improper use of the device.
- Subject to change without notice: The manufacturer reserves the right to modify the technical descriptions and the parts that they refer to without prior notice.

4.2 Improper use

The mortar mixer may only be operated in a technically perfect condition.

Only use the mortar mixer for the described use, any improper use shall result in the loss of the warranty claim.

Manipulations and modifications to the mortar mixer (electrical, mechanical changes, etc.) that have not been authorised in a written agreement with the manufacturer are considered to be prohibited and the manufacturer does not accept any claims for damages. We recommend only using original spare parts and accessories; otherwise the manufacturer assumes no liability.

Ensure that no hazardous situations occur during the work. The mortar mixer must be switched off immediately if it does not work properly and the manufacturer or their authorised service personnel must be notified immediately.

Not intended use and therefore not permissible are the following:

- the mixing of substances other than those specified in 4.1
- overfilling the mixing bowl
- the installation and operation of the mixer in ambient conditions other than those specified in 6.1

4.3 Information on the CE symbol

TESTING Bluhm & Feuerherdt test equipment bear the CE symbol.

The CE marking confirms the conformity of the product with the EC directives to be taken into account for the product and compliance with the "essential requirements" defined therein, the generally applicable level of protection. The conformity assessment procedure has been carried out in accordance with the applicable EC directives. The Council Decision 93/465/EEC on the modules to be used in the technical harmonisation directives for the different phases of the conformity assessment procedures and the rules for the affixing and use of the CE marking shall be taken into account.

4.4 Obligation of the operator

The operator must ensure that they do not put themselves or any others at risk. Only persons who have been instructed in the operation are allowed to operate the device independently.

If the operating safety is compromised by faults or damage to the device, it must be taken out of operation immediately and must only be used again after the elimination of all hazards.

Check that the indication on the nameplate matches your mains voltage.

If the device or the connection cable is damaged, pull out the mains plug immediately.

 <p>Danger</p>	Take the necessary precautionary measures when mixing, in order to prevent dust from getting into the eyes, mouth and nose from when mixing.
---	--

- The use, lifting, installing, waiting and scrapping of the mortar mixer may only be carried out by qualified personnel. Qualified employees are persons who are authorised to work with the machine on the basis of their experience and knowledge concerning the operation of the mortar mixer and the directives, regulations and handling. The user must be carefully trained, in order to operate the machine and safety equipment with which the machine is equipped, in order to avoid an incorrect use. Safety equipment must always be installed and checked daily.
- Manipulations and modifications to the machine (electrical, mechanical changes, etc.) that have not been authorised in a written agreement by the manufacturer are considered to be prohibited and the manufacturer does not accept any claims for damages.
- Ensure that no hazardous situations occur during the work. Stop the machine immediately if it does not work properly, and immediately notify the manufacturer or their authorised service personnel.
- Do not insert any wires or tools into the existing openings.

4.5 General safety instructions

<p>Caution</p> 	All instructions must be read. Failure to comply with the instructions below may result in electrical shock, fire, and/or serious injury.
--	---

1) Workplace

- Keep your work area clean and tidy. Disorder and unlit work areas may result in accidents.
- Do not work with the mortar mixer in hazardous environments where there are flammable liquids, gases or powders. Electrical tools produce sparks that may ignite the powder or vapours.
- Keep children and other persons away from the device during use. If you are distracted, you may lose control of the device.

2) Electrical safety

- The connector plug of the mortar mixer (Schuko) must fit into the intended Schuko socket. The plug must not be changed in any way. Do not use adapter plugs together with protective earthing devices. Unchanged plugs and suitable sockets reduce the risk of electrical shock.
- Avoid bodily contact with grounded surfaces, such as pipes, heaters, stoves and refrigerators. There is an increased risk of electrical shock if your body is grounded.
- Keep the device away from rain or moisture. The penetration of water into an electrical appliance increases the risk of electrical shock.
- Do not use the cable to carry the device, to hang it, or to pull the plug out of the socket. Keep the cable away from heat, oil, sharp edges or moving parts. Damaged or entangled cables increase the risk of electrical shock.

3) Safety of persons

- Be attentive, pay attention to what you do, and work rationally. Do not use the device if you are tired or under the influence of drugs, alcohol or medication. A moment of carelessness during use of the device may result in serious injury.
- Wear personal protective equipment and always wear protective goggles. Wearing personal protective equipment, such as a dust mask, non-slip safety shoes, reduces the risk of injury.
- Remove adjusting tools or wrenches before turning the mortar mixer on. A tool or key that is in a rotating part of the device can cause injury.
- Wear suitable clothing. Do not wear loose clothing or jewellery. Keep hair, clothing and gloves away from moving parts. Loose clothing, jewellery or long hair can be caught in moving parts.

4) Careful handling and use of power tools

- Unplug the power plug before unplugging the power cable or changing any accessories. This precautionary measure prevents an unintentional turning on of the device.
- Keep unused power tools out of reach of children. Do not allow persons to use the device who are unfamiliar with the device or who have not read the instructions. Power tools are dangerous when used by inexperienced persons.
- Maintain the device with care. Check whether movable parts of the device are functioning properly and do not jam, whether parts are broken or damaged, in such a way that the function of the device is compromised. Have damaged parts of the device repaired before use. Many accidents are caused by poorly maintained machines.
- Use power tools, accessories, insertion tools, etc. according to these instructions and as required by this particular type of device. Take into account the working conditions and the work to be carried out. The use of power tools for applications other than the intended ones can result in dangerous situations.

5) Service

- Only let your device be repaired with original spare parts and by qualified specialist personnel. This ensures that the safety of the device is maintained.

4.6 Protective clothing

The operator must ensure that the personnel wear the necessary protective clothing, e.g.:

- Safety shoes
- Suitable outer clothing
- Protective gloves
- Facial protection
- Respiratory protection

4.7 Periodic inspection

The mortar mixer must be checked at regular intervals for its operational safety. There are national regulations that must be complied with.

5. Description of the mortar mixer

5.1 Mechanical design

The housing of the mortar mixer is made of stable light metal casting.

The mixer is made of stainless steel and is coupled with the planetary gear by a snap closure. It rotates on its own axis and is moved by an electric motor at 2 fixed speeds in a planetary motion around the bowl axis. Mixer and gear head move in opposite directions.

The mixing bowl consists of NIROSTA steel and can be removed from the working position after lowering.

The contours of the mixer and mixing bowl are in accordance with the EN 196-1 standard and guarantee a distance of 3.0 ± 1.0 mm between mixing bowl and mixer.

The distance in vertical height can be readjusted as described in section 6.9.

The electromechanical sand feed is made of steel plate. In the housing of the sand feed there is an electromagnet that moves the locking plate via a piston rod. The locking plate is secured by a spring and can be opened at a standstill or during low speed.

5.2 Electrical design

The supply voltage/frequency for the mixer can be **110-240 volts, 50-60 Hz**.

The mains connection is made by a 2-pin Schuko plug, with potential equalisation.

The main switch, which separates the mixer from the mains, is located on the right side of the mortar mixer.

1) Components in the rear of the mortar mixer

- I/O board, power supply, frequency inverter with line filter, fuse

After disassembling the back wall, the fuses for the short circuit protection of the mixer are accessible.

2) Components in the headspace of the mortar mixer

- Coloured display and operating unit
- 8 function buttons
- Buzzer
- Unlockable emergency stop button
- Programming interface
- Side mounted main switch

The display and operating unit is connected to the I/O board on the fold-out mounting frame by means of a shielded control cable that can be plugged in on both sides.

5.3 Safety devices

The mortar mixer is equipped with the following safety devices:

1. **Emergency stop switch**
When the EMERGENCY STOP switch is pressed, the drive motor is disconnected from the supply network by the safety module.
To reactivate the control, the EMERGENCY STOP switch must be returned to its basic position by turning it in the direction of the arrow. Then press the R button to confirm the operational readiness.
2. **Inductive electronic proximity switch**
The proximity switch in the mixing bowl holder is damped by the bottom flange of the mixing bowl and monitors its correct fit in the holder.
If the mixing bowl is not inserted into the holding fixture, the safety module prevents operation of the mortar mixer. Confirmation via the display and operating unit.
3. **Inductive electronic proximity switch**
The proximity switch in the mixing bowl lifting device is damped when the mixing position is reached and monitors the correct mixing position.
If the mixing bowl is not in the mixing position, the operation of the mortar mixer is prevented by the safety module. Confirmation via the display and operating unit.
4. **Fixed protective cover**
The mixing bowl is covered in the mixing position by a solid protective cover surrounding the mixer on all sides.

6. Preparations for commissioning

6.1 Installation location/ambient conditions

<p>Caution</p> 	<p>The operation of the mortar mixer is only permissible in dry spaces!</p>
--	---

The following limit values apply:

Ambient temperature	DIN EN 60204-1, 4.4.2	+5°C	up to	+40°C
Humidity	DIN EN 60204-1, 4.4.3	30%	up to	95%

<p>Note</p> 	<p>Place the mortar mixer on a stable, level surface.</p>
--	---

6.2 Electrical connection

A protective connection socket **110-240 volts 1Ph+1N+1PE, 50-60 Hz** must be used for the mains connection of the mortar mixer.

The fuse should be fused with a maximum of 16 A. A residual current circuit breaker is recommended.

Insert the Schuko plug, the mains cable of the mortar mixer, into the mains connection socket.

<p>Caution</p> 	<p>Safety advice! Work on electrical equipment may only be carried out by qualified personnel!</p>
--	--

6.3 Lowering and removing the mixing bowl

Loosen the right hand lever at the right side of the mortar mixer and push it to the front as far as it will go. The mixing bowl lowers.

The container holder is in the lowered position. Turn the mixing pot on the side handles anti-clockwise until the two arrows on the mixing pot and on the container holder are perpendicular to each other. Lift the mixing pot upwards and slightly tilted forward until the clamping jaw is no longer in the container holder. Now tilt the mixing pot backwards and pull it out.

6.4 Loosening and removing the mixer

Use the left hand to hold the mixer and firmly hold the cord ring of the mixer attachment with the right hand.

Release the cord ring anti-clockwise until it can be moved upwards. Now pull the mixer downwards.

6.5 Inserting and tightening the mixer

Insert the mixer into the snap closure of the mixer with a slight rotary motion until the stop is detected. Hold the mixer with the left hand and turn the cord ring until it drops approx. 10 mm downwards. Now tighten the cord rings by turning them clockwise with the right hand.

6.6 Inserting and tightening the mixing bowl

The container holder is in the lowered position. Use the side handles to use the mixing pot. The red arrow must point forwards. The mixing pot must be inserted in such a way that both arrows on the mixing pot and on the container holder are placed one above the other. Let it lean forward slightly and allow the mixing pot to slide easily. To lock, the mixing pot is tightened clockwise.

6.7 Placing the mixing bowl in the mixing position

Move the hand lever to the right, then backwards until it stops and lock to the left. The mixing bowl is locked in the mixing position.

6.8 Adjusting the distance between the mixing bowl and mixer

If the distance between the mixing bowl and mixer is bigger than the applicable standard, this can be adjusted.

First, the mixing bowl must be lowered and removed (see point 6.3).
Then loosen and remove the mixer (see point 6.4)

Now the two clamping screws (see Figure 1), on the holder for the mixing bowl can be loosened by approx. 1 rotation.

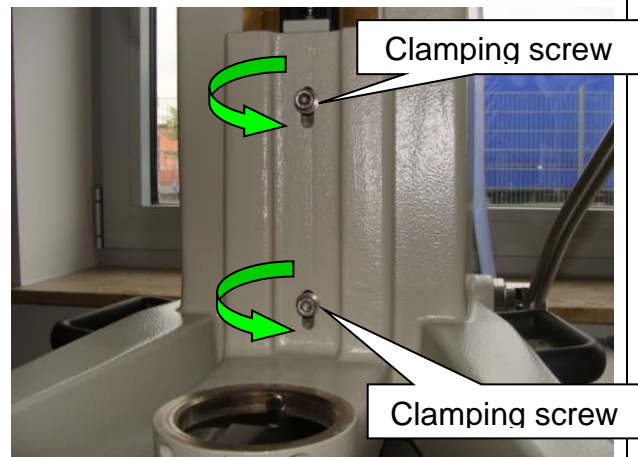

Figure 1

Now loosen the lock nut of the adjusting screw (see Figure 2), at the upper end of the mixing bowl holder.
Then use the adjusting screw to set the distance.

- Turning the adjusting screw clockwise will lessen the distance.
- Turning the adjusting screw anti-clockwise will increase the distance.

For checking, the distance template (TESTING Art. No.: 1.0203.07) can be used to check the distance between the mixer and the bowl.

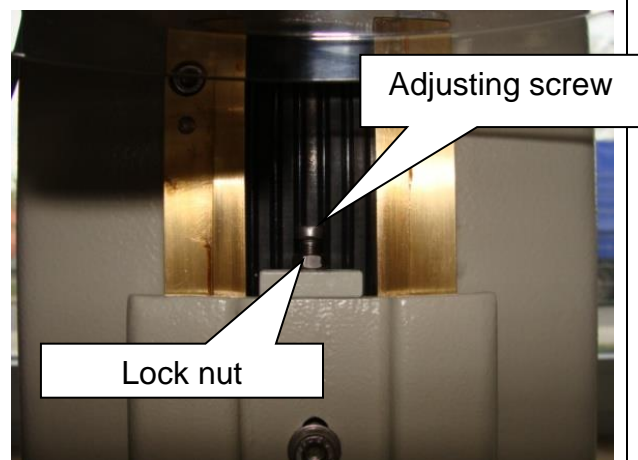

Figure 2

If the distance is correctly set, the lock nut, the adjusting screw and the two clamping screws must be firmly tightened on the bracket for the mixing bowl. The contact protection must be re-assembled, the mixing bowl and the mixer can now be used.

7. Technical details

Available space	approx.415x590 mm	Power consumption	0.37 kW/ 0,55 kW
Height	approx. 590 mm	Alternating current	110-240 V
Weight	approx. 58 kg	Frequency	50-60 Hz
		Number of phases	1

Speeds of the mortar mixer according to DIN EN 196-1

	Rotation (min ⁻¹)	Planetary movement (min ⁻¹)
low speed	140 ± 5	62 ± 5
high speed	285 ± 10	125 ± 10

Diagram of the drive components
(Counter-rotating direction of the gear head to the mixer)

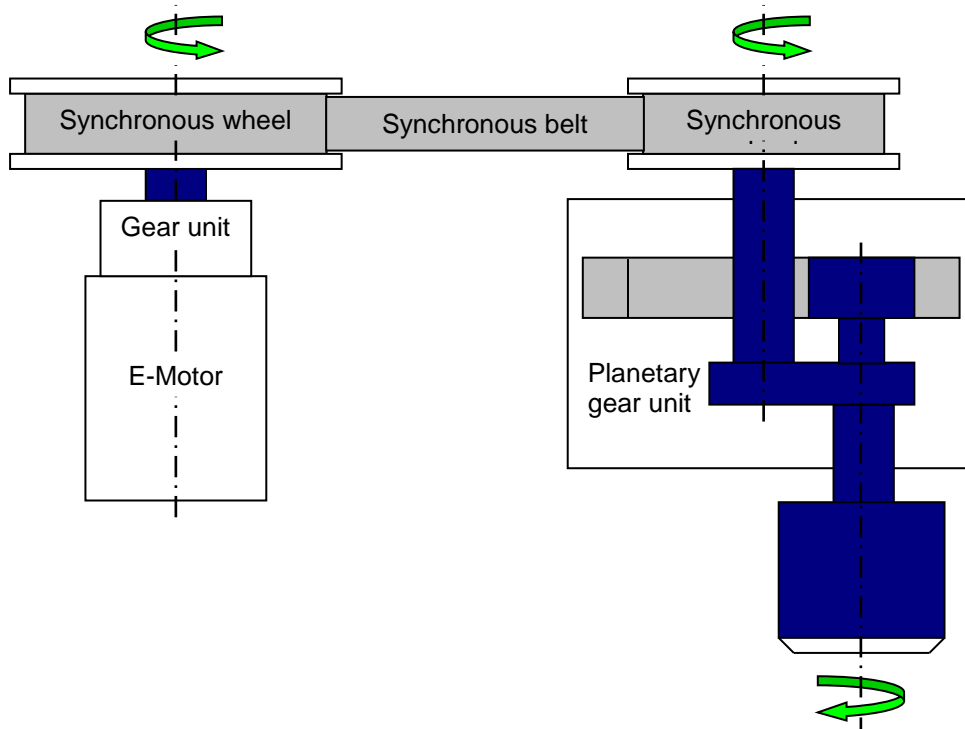



8. Operation

8.1 Switching on the mortar mixer

After the mains connection has been made and the main switch has been switched on, the inductive proximity switches for the monitoring "**mixing bowl is inserted**", "**mixing bowl is in mixing position**" and the operating and signalling unit are supplied with control voltage.

If the EMERGENCY STOP button is unlocked, the mixing trough is inserted and the mixing mode is ready, the mortar mixer is ready for operation. If the EMERGENCY STOP button is pressed, the mixing trough is not inserted or not in the mixing position, a red-coloured error message is displayed on the display. The mortar mixer has "**No operational readiness**" and cannot be started. In these instances, a description of how to correct the error is shown on the display (see point 12).





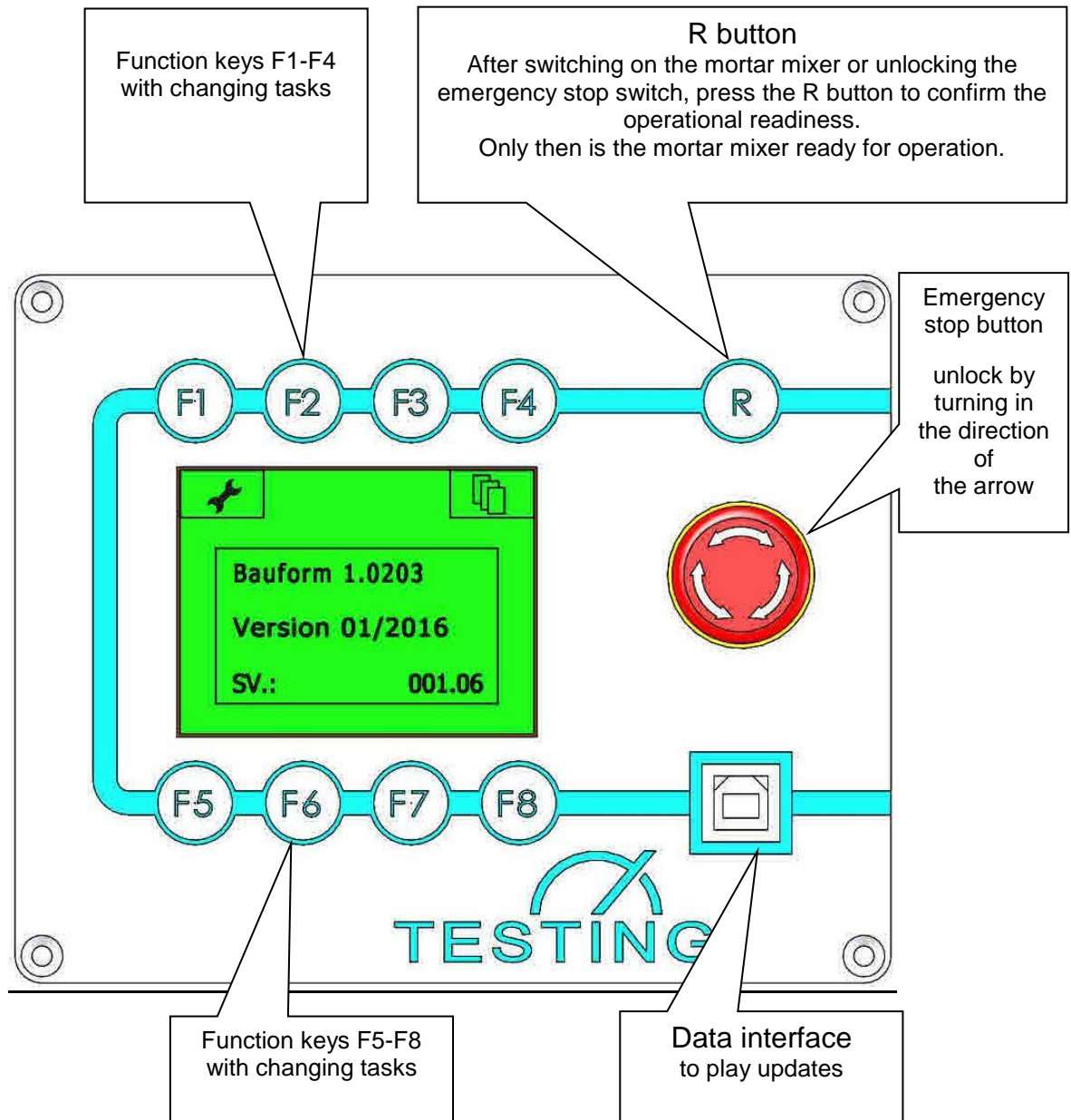





<p>Caution</p> 	<p>Safety advice!</p> <p>After switching on the mortar mixer or after activating the EMERGENCY STOP button, the warning message must be confirmed on the display by pressing the R button.</p> <p>This confirms the operational readiness!</p> 
--	---

8.2 Explanation of the control unit



<p>Note</p> 	<p>By pressing the function keys F1 to F8, the commands shown on the display can be started or ended.</p>
---	---

8.3 Key symbol

Symbol	Function	Description of the function
	Info	Here you can find corporate and contact information
	Service menu	Basic settings can be set here (operator language, display brightness)
	Start	Starts the selected function (simultaneously starts a time display)
	Stop	Stops the selected function (the time display is now ended)
	Pause	With the start of the pause, a time display for checking the elapsed pause time starts
	Up	For the numeric selection of a larger number
	Down	For the numeric selection of a smaller number
	Enter	Confirmation symbol for acceptance of an input
	Back	Return to the previous menu
	Language selection	Here 8 display languages can be chosen from
	Display brightness	The brightness of the display can be adjusted here
140/62	140/62 U/min	Starts the selected speed
285/125	285/125 U/min	Starts the selected speed

8.4 Start conditions

1. Mains connection must be established.
2. Connect the mortar mixer MAIN SWITCH to the "-I-" or "-ON-" position.
3. "-EMERGENCY-OFF" switch must be unlocked (to unlock, turn the red switch in the direction of the arrow).
4. Insert and tighten the mixer (see point 6.5).
5. Insert and tighten the mixing bowl into the bowl holder
6. (see point 6.6).
7. Place the mixing bowl in the mixing position (see point 6.7)
8. Press the R button
9. The function keys can now be used to operate the mortar mixer and to request the corresponding functions, depending on the model.

8.5 Basic settings in the service menu

<p>The mortar mixer is switched on with the main switch. If the starting conditions (point 9.4) are complied with, then wait briefly (the system data is loaded).</p>	
<p>The message shown here is displayed on the display.</p>	
	<p>Pressing the R button will quit the operating mode! In order to access the service menu, please press F1!</p>

<p>Note</p> 	<p>If the chance to switch to the service menu has been missed, you can restart it by switching the main switch off and on again.</p>
---	---

If the R button is pressed, the design and version of the mortar mixer, as well as the software version, are all displayed for approx. 3 seconds.



SV.: 001.06 may have been replaced by a newer successor version.

During this time, press the **F1** key to access the service menu or press the **F4** key to access corporate and contact information. If no selection is made here, the operating menu is switched after approx. 3 seconds.

Display after pressing **F1**



Display after pressing **F4**



Selectable functions:

F5 ⇒ Opening with code only possible (factory settings).

F6 ⇒ Language selection, here you can choose from 8 different languages (DE/GB/RU/FR/ES/PT/IT/PL).

F7 ⇒ at present without function.

F8 ⇒ Setting the display brightness

F4 ⇒ To return to the operating menu, press the back space **F4** 1x.

F4 ⇒ To return to the operating menu, press the back space **F4** 1x.

Display after pressing the
back space **F4**



Wait approximately 3 seconds in the initial menu, then it
automatically switches to the operating menu.

8.6 Setting the language

A selection of different languages is possible via the service menu, as described below.

After switching on the mortar mixer with the main switch (see point 9.1), retrieve the service menu by pressing **F1**.

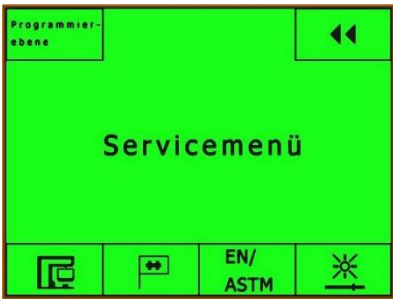
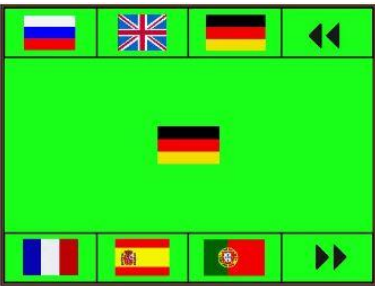
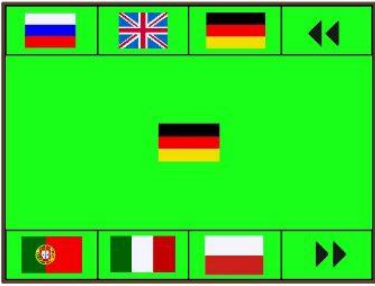
F1 has been pressed Service menu	
Display after pressing F1	Description
	<p>F6 ⇒ In order to choose an operator language in the service menu, press F6.</p>
Display after pressing F6	Description
	<p>Use the appropriate function key to select the desired operator language.</p> <p>Go back to the service menu with F4, then press F4 again to enter the working menu.</p> <p>If the desired language is not available, scroll to F8.</p>
Display after pressing F8	Description
	<p>Use the appropriate function key to select the desired operator language.</p> <p>Go back to the service menu by pressing F4 twice, then press F4 again to enter the operating menu.</p>

8.7 Setting the display brightness

To set the display backlight according to the local conditions, proceed as described below.

After switching on the mortar mixer with the main switch (see point 9.1), retrieve the service menu by pressing **F1**.

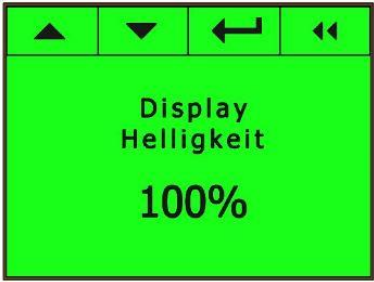
F1 has been pressed Service menu	
Display after pressing F1	Description
	<p>F8 ⇒ To set the backlight in the service menu, press F8.</p>
Display after pressing F8	Description
	<p>Press the corresponding function key F1 or F2 to select the desired percentage of display brightness.</p> <p>Confirm with F3.</p> <p>Press F4 to return to the service menu, then press F4 again to enter the operating menu.</p>

8.8 Setting the soft start

In order to prevent the mix from splashing out, it is possible to set a gentle start.

1.	The setting is made in the service menu
2.	Press F2 , using the up \blacktriangle or down symbols \blacktriangledown , select the appropriate setting function for soft start.
3.	Activate the setting function by pressing F3 (flashing background indicates activity) and select the desired start-up time with F2 or F1 . Soft start can be set between 0-5 seconds.
4.	Press F3 and take over the selection. (Background permanently black)
5.	Press F4 twice to switch to the work menu.
6.	After pressing F4 , the work menu is displayed.

8.9 Selection of standardized or variable speed (optional)

Note	
	This selection is only supported if it has been ordered.

Under certain operating conditions, the possibility of setting variable speeds is desirable. In a separate display menu, the speed of the paddle can be changed continuously using the up \blacktriangle or down \blacktriangledown symbols. A speed indicator on the display shows the rotation of the gear head (low speed) and that of the paddle (high speed). The maximum speed that can be set is limited at 153/350 rpm = 60 Hz and the minimum speed at 36/82 rpm = 15 Hz. This corresponds to the technical possibilities of the geared motor used.

8.9.1 Setting the variable speeds

1.	The setting is made in the service menu
2.	Press F2 , using the up \blacktriangle or down symbols \blacktriangledown , select the appropriate speed setting function.
3.	Activate the setting function by pressing F3 (flashing background indicates activity) and select the desired function with F2 or F1 . variable = variable speeds
4.	Press F3 and take over the selection. (Background permanently black)
5.	Press F4 twice to switch to the work menu.
6.	After pressing F4 , the work menu is displayed.

8.9.2 Working with the variable speeds

 Note	<p>The current speed is shown on the display. The low numerical figure shows the gear head rotation, the high numerical figure shows that of the paddle. The mixer is at the low normalized speed (62/125 rpm = 25 Hz) started.</p>
---	---

Pos.	description
1.	Press F5 START to start rotating the paddle. Now the speed is shown in real time on the display.
2.	To make the stirrer turn faster, press F7 several times. The target frequency preset by pressing F7 is shown in the bottom right of the display. At the same time, the actual frequency is displayed. These differ until the target and actual agree.
3.	To make the stirrer turn more slowly, press F8 several times The target frequency preset by pressing F7 is shown in the bottom right of the display. At the same time, the actual frequency is displayed. These differ until the target and actual agree.
4.	Press F6 STOP to stop the paddle.

8.9.3 Finish working with the variable speeds

Pos.	description
1.	Press F1 to access the service menu, where you can switch to normalized speeds.



8.9.4 Setting the normalized speeds

1.	The setting is made in the service menu
2.	Press F2 , using the up \blacktriangle or down symbols \blacktriangledown , select the appropriate speed setting function.
3.	Activate the setting functions by pressing F3 (flashing background indicates activity) and select the desired function with F2 or F1 . fixed = standardized speeds
4.	Press F3 and take over the selection. (Background permanently black)
5.	Press F4 twice to switch to the work menu.
6.	After pressing F4 , the work menu is displayed.





8.10 Setting the signal

1.	The setting is made in the service menu
2.	Press F2 , using the up \blacktriangle or down symbols \blacktriangledown , select the appropriate setting function for the signal.
3.	Activate the setting functions by pressing F3 (flashing background indicates activity) and select the desired function with F2 or F1 . on or off
4.	Press F3 and take over the selection. (Background permanently black)
5.	Press F4 twice to switch to the work menu.
6.	After pressing F4 , the work menu is displayed.

8.11 Lowering or removing the mixing trough during the pause

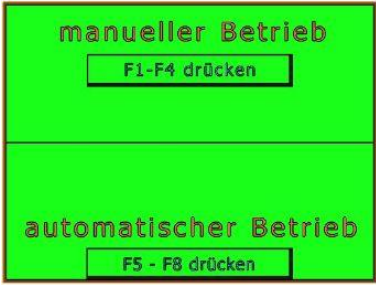
<p>Display after lowering the stainless steel bowl</p>	<p>During the lowering of the stainless steel bowl, the current total time from the start of a mixing speed and the elapsed time after pause start is displayed.</p>
	<p>No functions are active here. The functions assigned to the model cannot be retrievable until the mixing trough has been placed in the mixing position.</p>
<p>Display after removing the stainless steel bowl</p>	<p>During the lowering and removal of the stainless steel bowl, the current total time from the start of a mixing speed and the elapsed time after pause start is displayed.</p>
	<p>No functions are active here. It is only when the mixing trough has been inserted and placed in the mixing position that the functions assigned to the model can be retrievable.</p>

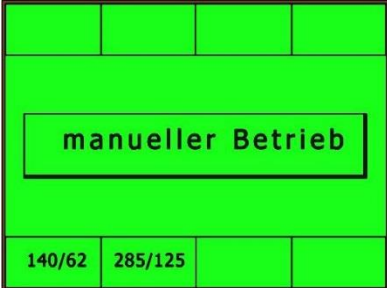
9. Starting the mortar mixer

The mortar mixer was switched on with the main switch (see point 9.1).	
Display	Description
	F1-F4 ⇒ In order to enter the manual mode.
<p>Note</p> 	In compliance with the applicable standards, appropriate quantities of cement, water and standard sand must be added to the mixing trough before starting.
	<p>The operating menu shown here is shown on the display and operating unit.</p> <p>F2 ⇒ Return to selection "manual operation" or "automatic operation"</p>
 <p>Danger</p>	After selecting a mixing speed, the mortar mixer will immediately start!
<p>Note</p> 	The mixing speeds can be switched directly, in other words without intermittent activation of the OFF button.

9.1. Selecting/stopping low speed

F5 Start the engine speed 140/62 rpm	
	<p>F5 ⇒ Starts the low rotary movement of the mixer.</p> <p>F7 ⇒ Press F7 to open the sand feed and start a time display. The standard sand (1350 g) ran through the sand feed in approx. 28 sec.</p>

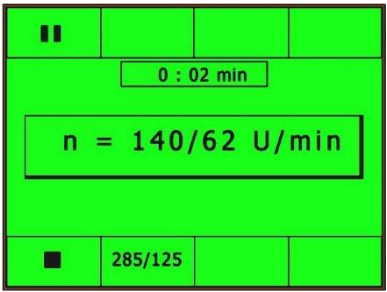
F5 Stop the engine speed at 140/62 rpm	
	<p>F5 ⇒ Stop (stops the rotational movement of the mixer and the elapsed time)</p>

9.2. Selecting/stopping high speed

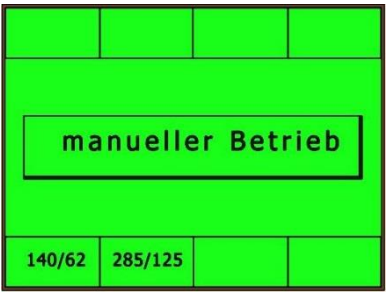
F6 Start the engine speed 285/125 rpm	
	<p>F6 ⇒ Starts the high rotational movement of the mixer.</p> <p>The sand feed cannot be opened.</p>

<p>F6 Start the engine speed 285/125 rpm</p>	
	<p>F6 ⇒ Stop (stops the rotational movement of the mixer and the elapsed time)</p>

9.3. Selecting pause





<p>F1 Pause</p>	
	<p>F1 ⇒ Press F1 to start the pause.</p> <p>F6 ⇒ Pre-selection but no start of mixing speed 285/125 rpm. Starts when F1 is pressed. <i>The total time is still displayed.</i></p>

<p>F1 Stop the pause</p>	
	<p>Display of the absolute time (top)</p> <p>F1 ⇒ Stop (stops the pause)</p> <p>Display of the pause time (below)</p>

<p>Note</p>  An information icon consisting of a lowercase letter 'i' inside a circle.	<p>The pause function can be activated at both speeds. For example: To scrape off the mortar built up on the stainless steel bowl.</p>
---	--

<p>Note</p>  An information icon consisting of a lowercase letter 'i' inside a circle.	<p>During the pause, the stainless steel bowl can be lowered and removed without interruption of the total running time.</p>
---	--

10. Error messages in the display

 <p>Keine Betriebsbereitschaft R-Taste drücken!</p>	<p>To make the mortar mixer ready for operation after switching it on, it is necessary to confirm the R button. R button: Resetting the EMERGENCY STOP function. After unlocking the emergency stop switch, press the R button to confirm the emergency stop status. Only then is the mortar mixer ready for operation again.</p>
 <p>Keine Betriebsbereitschaft Fehler im Frequenzumrichter!</p>	<p>Short-term message, which is automatically deactivated. <i>Internal time delays in the electronic components, which have no effect on the operating sequence, are responsible for this.</i></p>
 <p>Keine Betriebsbereitschaft Not-Aus entriegeln!</p>	<p>If the EMERGENCY STOP button is pressed, the following message appears on the operating and display unit: "No operational readiness" "Unlock EMERGENCY STOP" The unlocking is carried out by turning the red button⇒, the EMERGENCY STOP button is unlocked, the error message on the display unit goes out.</p>
 <p>Keine Betriebsbereitschaft Mischtrog in Position bringen!</p>	<p>If the mixer trough holder is lowered, the following message appears on the operating and display unit: "No operational readiness" "Place mixing trough in mixing position" If the mixing trough is placed in the mixing position, the error message on the display unit goes out.</p>
 <p>Keine Betriebsbereitschaft Mischtrog einsetzen!</p>	<p>If the mixing trough is removed from its holder, the following message appears on the operating and display unit: "No operational readiness" "Use the mixing trough"⇒ If the mixing trough is inserted, the error message on the display unit goes out.</p>

11. Switching off the mortar mixer

The display and control unit, as well as the electrical components, are disconnected from the power supply after the main switch is disconnected and therefore switched off. If the mortar mixer is not put into operation for an extended period of time, the mains connection should be disconnected from the mains socket by removing the mains plug.

12. Warranty

In principle, our **General Conditions of Sale and Delivery** are applicable.

The manufacturer assumes liability that these operating instructions have been prepared in accordance with the technical and functional parameters of the delivered mortar mixer. The manufacturer reserves the right to add additional information to these operating instructions.

The manufacturer grants the legal warranty.
Exceptions to this warranty are wear parts.

The manufacturer guarantees a trouble-free operation only if the guidelines in these operating instructions are observed and when used as intended.

The manufacturer is not liable for damage resulting from the incorrect use of the mortar mixer or the failure to comply with the guidelines and codes of conduct contained in these operating instructions.

Warranty claims made to the manufacturer are excluded if the mortar mixer is modified without the written consent of the manufacturer, in terms of its construction or functional design.

13. Issue date of the operating instructions

4th edition
March 2017

14. Copyright

The copyright remains with the company

TESTING Bluhm & Feuerherdt GmbH

These operating instructions are only intended for the operator and their personnel. It contains guidelines and indications which may not be

- reproduced
- distributed or
- otherwise disclosed.

Violations can result in prosecution.

15. Address of the manufacturer

TESTING Bluhm & Feuerherdt GmbH

Motzener Str.26b
12277 Berlin
Tel.: 030 / 7109645-0
Fax: 030 / 7109645-98
E-mail: info@testing.de

16. Cleaning and maintenance

16.1 Cleaning the mortar mixer

If external cleaning of the mortar mixer is necessary, depending on the frequency of use or ambient conditions, proceed as follows:

1. Turn off the MAIN SWITCH, position "-0-"
2. Disconnect the mortar mixer from the mains supply
3. Remove any loose dust using a brush or suction
4. If necessary, the mortar mixer can be cleaned externally with a damp cloth.

Normal household cleaners can be used as aids.

<p>Caution</p> 	<p>Any cleaning with pressure, spray or gushing water, as well as water being introduced with dripping sponges or similar unsuitable aids, results in sustained damage to mechanical and/or electrical or electronic components of the mortar mixer.</p>
--	--

16.2 Maintenance of the mortar mixer

The mixer is virtually maintenance-free. The spur gear unit of the three-phase motor and the planetary gear unit of the mixer head are provided with sufficient lubrication for approximately 5,000 operating hours.

After several years of operation, a thorough cleaning and refilling of the gear units with suitable lubricants is recommended.

Due to the very compact design of the mixer, we recommend that you use our maintenance service.

16.3 Control and adjustment

Depending on the frequency of use of the mortar mixer, a check of the distance between the mixer and mixing bowl is required (see point 6.8).

This distance is increased by normal wear of the mixer and may need to be readjusted.

16.4 Decommissioning the mortar mixer

1. Switch off the MAIN SWITCH, position "-0-" or "-OFF-"
2. Disconnect the mortar mixer from the mains supply
3. Cover the mortar mixer with the dust cover
4. Store the mortar mixer in a dry place

<p>Caution</p> 	<p>Safety advice!</p> <ol style="list-style-type: none">1. Work on electrical equipment may only be carried out by qualified personnel!2. In the event of a fault and/or before disassembling covers, pull out the mains plug!
--	--

<p>Note</p> 	<p>In the event of a fault, the mortar mixer must be disconnected from the mains supply. After disassembling the upper and lower covers, the safety fuses of the individual modules are accessible. These can be checked and replaced with new, identical safety fuses if necessary.</p>
---	--

17. Spare parts - supply and customer service

Spare parts list		
Pos.	Description	Item number
1	Display and operating unit	1.0203-09
2	I/O board	1.0203-10
3	Stainless steel bowl	1.0203.03EN
4	Stainless steel stirrer	1.0203.02EN

Please contact the following address to clarify any technical matters or request the supply of spare parts:

TESTING Bluhm & Feuerherdt GmbH
Motzener Str. 26b
12277 Berlin

Tel.: +49 30 7109645-0
Fax: +49 30 7109645-98
E-mail: technik@testing.de

18. Scrapping, disposal

To prevent damage to the environment, always ensure that the used mortar mixer is only disposed of by authorised specialist companies or by the manufacturer.

The product and the packaging material are made of recyclable materials. The separate, environmentally friendly disposal of material residues promotes the recycling of recyclable materials.

This product complies with Directive 2002/96/EC of the European Parliament and Council on Waste Electrical and Electronic Equipment. The product is identified by the following symbol:



Disposal instructions are provided by the municipal authorities.

19. I/O board

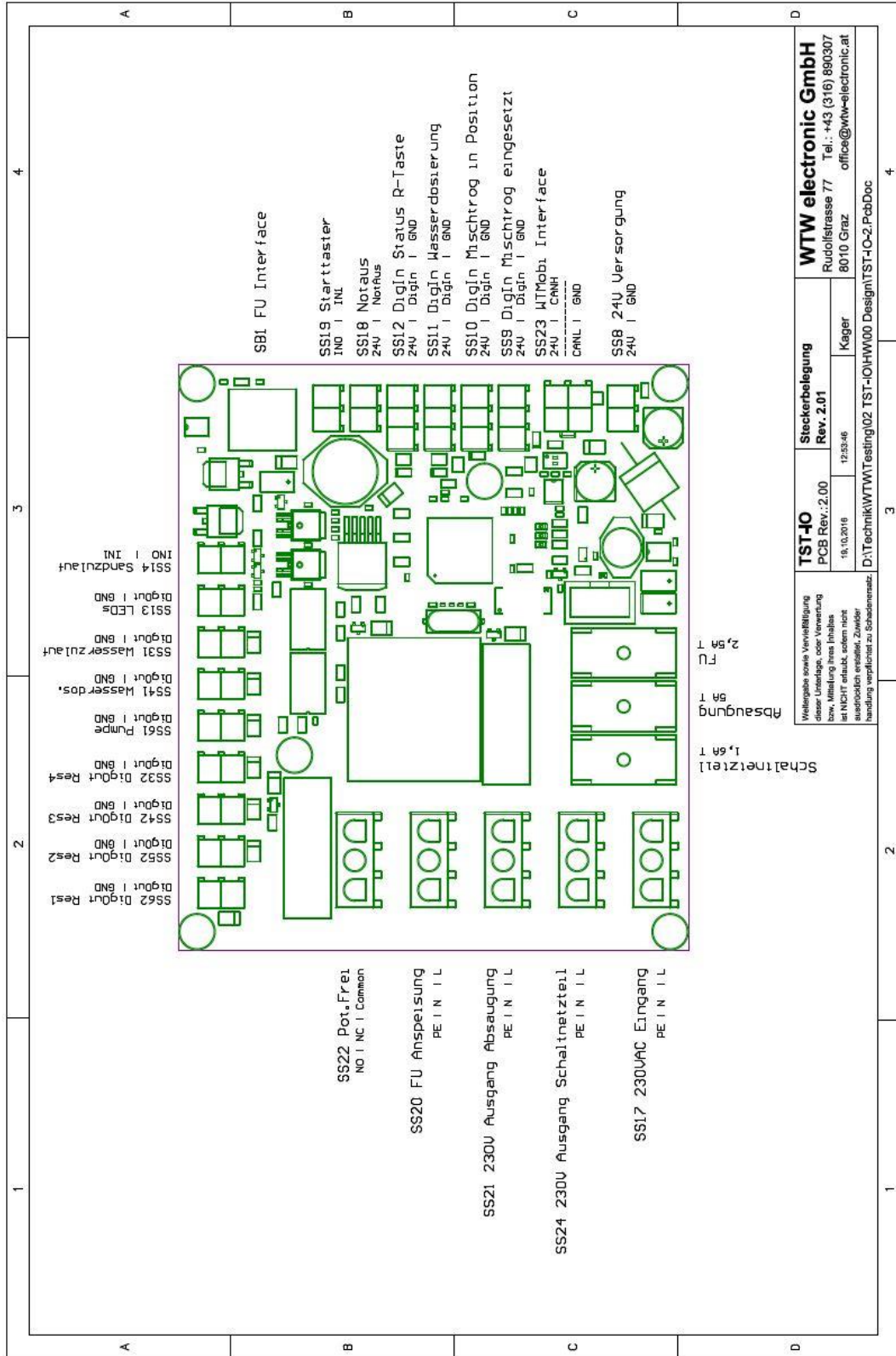

20. Scircuit diagram

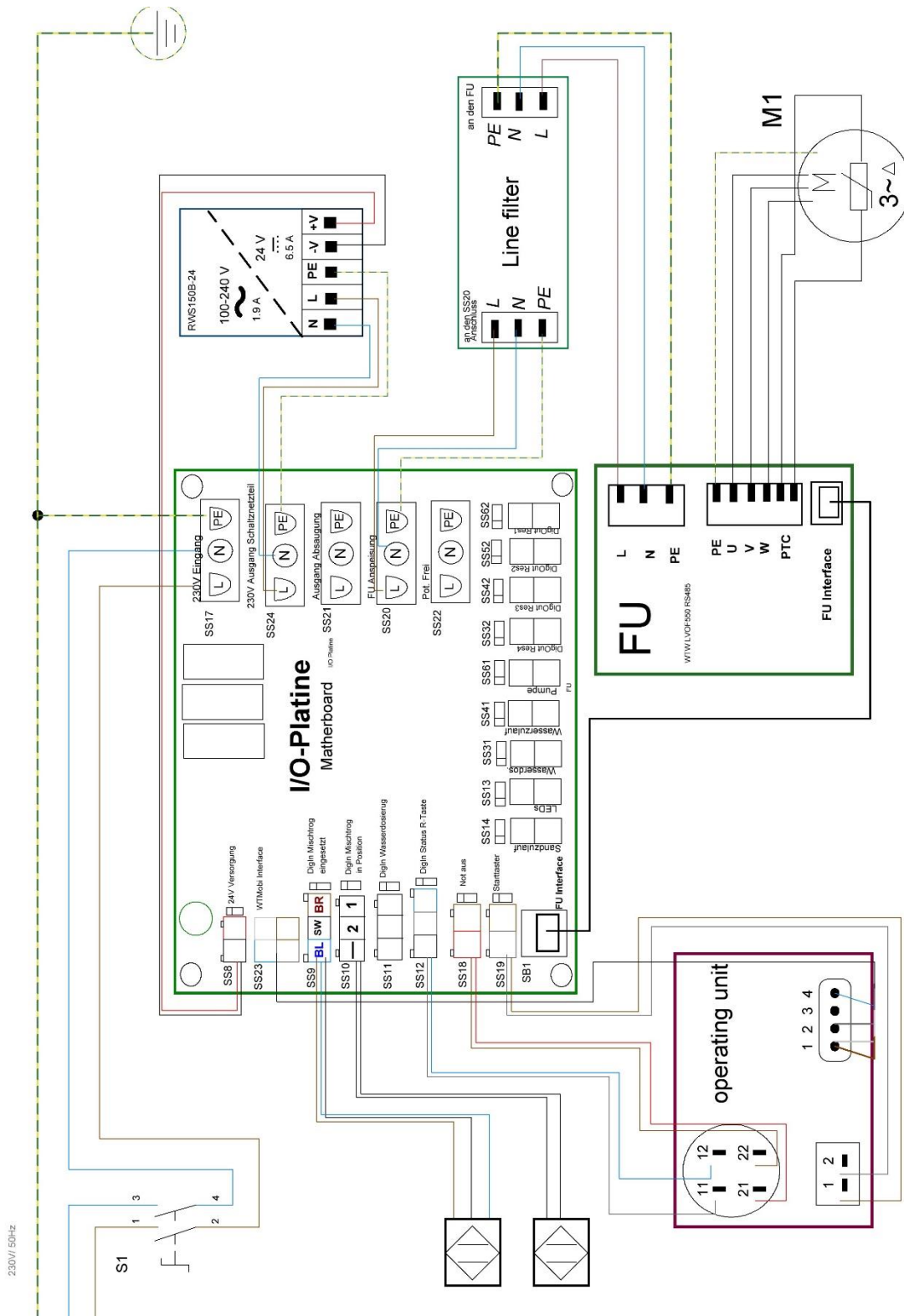

EC Declaration of Conformity
according to Machinery Directive 2006/42/EC Annex II 1.A

The manufacturer/distributor

TESTING Bluhm & Feuerherdt GmbH
Motzener Str. 26b
12277 Berlin

hereby declares that the following product

Product name: Mortar mixer
Manufacturer: TESTING
Serial number: continuous
Serial/type designation: 1.0203

complies with all relevant provisions of the aforementioned Directive, as well as the other applicable directives (hereinafter) including their amendments applicable at the time of the declaration.

The following additional EU directives were applied:

EMC Directive 2014/30/EU
Low Voltage Directive 2014/35/EU

The following harmonised standards were applied:

DIN EN 12151	Machines and equipment for the preparation of concrete and mortar - safety requirements
EN 349:2008	Safety of machinery - Minimum distances to prevent crushing of body parts
EN ISO 12100-1	Safety of machinery - basic concepts, general design principles - Part 1: Basic terminology,
EN ISO 12100-2	Safety of machinery - basic concepts, general design principles - Part 2: Technical principles
EN ISO 14121-1	Safety of machinery - Risk assessment - Part 1: Guidelines (ISO 14121-1:2007)

The following national or international standards (or parts/clauses thereof) and specifications have been applied:

Name and address of the person authorised to compile the technical documentation:
Jens Petraneck

Place: TESTING
Date: 12.03.2017



(Signature)
Jochim Feuerherdt Managing Director



(Signature)
Jens Petraneck Production Manager