

## Operating Manual

### Electronic Blaine Air-Permeability Apparatus for determining the fineness of cement

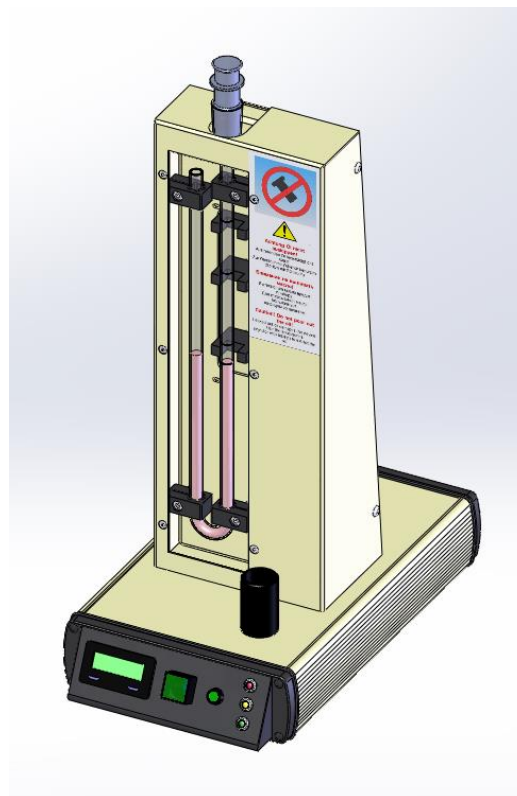

## Importance of this Operating Manual:

**Warning:** It is expected that Users and Operators read and understand this entire Operating Manual before putting the system into operation. Reading and understanding this entire Operating Manual is absolutely necessary before operating the system.

## Contents

Page no.:

<b>1. General information</b>	<b>3</b>
1.1 Manufacturer's designation	3
1.2 Purpose for which this system has been designed	3
1.3 Conditions under which this system may NOT be used	4
1.4 Guarantee	4
1.5 Basic safety instructions	5
1.6 Acceptance of the product and transport	6
1.6.1 Acceptance of the product	6
1.6.2 Transport	7
1.7 Scope of delivery	7
1.8 Instructions for electrical connection	8
<b>2. Characteristics of the apparatus</b>	<b>9</b>
2.1 Basic structural design	9
2.2 Technical data	9
<b>3. Placing the Apparatus into operation</b>	<b>10</b>
3.1 Pump performance	11
<b>4. How to conduct the test</b>	<b>12</b>
<b>5. Checking and maintenance</b>	<b>13</b>
<b>6. Troubleshooting</b>	<b>14</b>
<b>7. Shutting down the system for lengthy periods</b>	<b>15</b>
<b>8. Scrapping</b>	<b>15</b>
<b>9. Spare parts and services</b>	<b>16</b>
9.1 Date of issue of this Operating Manual:	16
9.2 Copyright	16
9.3 Address for technical support and spare-parts ordering	16
<b>10. Spare-Parts List</b>	<b>17</b>

### Attachments:

Declaration of conformity  
Record of measurement and testing at the manufacturer's plant  
Safety Data Sheet

## 1. General information

### 1.1 Manufacturer's designation

- Manufacturer's designation: Blaine Apparatus (please see the cover page of this Operating Manual)
- Designation of the model itself: Please see the nameplate (rating plate) on the unit. It provides all the characteristics and the electrical rating data.

### 1.2 Purpose for which this system has been designed

This Operating Manual contains the information required for operation of the products described here, for the purpose for which they have been designed. This Operating Manual is intended to be used only by technically qualified staff.

“Technically qualified staff” is defined as those persons who – as a result of their training; their experience; the instructions which they have received; as well as their knowledge of the relevant standards, regulations, accident-prevention regulations, and conditions of product operation in the company – have been authorized by the person responsible for the safety of the company facilities to carry out the activities and actions required for operation of the equipment described below, and who can recognize and prevent any possible dangers arising from such operation (this definition of technically qualified staff).

The User must by all means observe the requirements and limit values, as well as all safety instructions, given in this Operating Manual. Any use of this device not in conformity with these stipulations shall be considered to be in violation of the use for which this system was intended. If this device must be operated under special conditions, or with special modes of operation, then this shall be authorized only after consultation with the Manufacturer, and after obtaining his prior and express approval.

The fineness of grind can be determined according to the Blaine technique and is indicated as the specific surface (Blaine value). The semiautomatic apparatus serves exclusively for determination of the specific surface of powders, and for fast analysis of characteristic operational values. The Blaine value is not a measure of granulometric distribution. The Blaine value can therefore be used only to a limited degree to evaluate the suitability of a type of test material for a certain use.



<p>Caution</p> 	<p>The instructions given in this Operating Manual apply only for the correct application of the apparatus. In order to correctly conduct tests, the User and Operator must observe the specific standards that apply for the testing being conducted.</p>
--	--

Please take the time to read this Operating Manual carefully. It describes how you safely operate the machine.

Please keep this Operating Manual to hand at all times, during the entire life cycle of this apparatus. Please refer to it whenever you have a question on the operation of this apparatus.

The Manufacturer cannot accept any responsibility for any damages that occur owing to false use of this apparatus.

This operating manual contains safety instructions that are to be observed in order to exclude any risk of fatalities, injuries, damage to the equipment or improper operation. Safety markings are as follows:

<p>Caution</p> 	<p>This warning refers to dangers that could cause material damage.</p>
<p>Danger</p> 	<p>This warning refers to dangers that could cause severe injuries or even fatalities.</p>
<p>Note</p> 	<p>Provides practical advice on operation</p>

### 1.3 Conditions under which this system may NOT be used

This Blaine Apparatus was not intended for use under the following conditions or with the following actions being taken. It may therefore NOT be used under such conditions or in connection with the following actions:

- Do not disassemble this system. Do not try to repair it or to modify it.
- Operate this product only with a mains electrical system which satisfies the ratings for voltage and current as given in this Operating Manual.
- The apparatus may not be operated in locations which are subject to the following conditions or substances: Ice formation, Heat radiation, Formation of condensation water, Dust, Corrosive gases, Vibrations, Severe physical impact (jolts), High relative humidity, Excessive temperature fluctuations
- Do not tamper with the liquid in the manometer. As recommended in the relevant standard. This liquid can cause serious health.

### 1.4 Guarantee

Our **General Terms of Sales and Delivery** apply in all cases.

The Manufacturer guarantees that this Operating Manual has been prepared in conformity with the technical and functional parameters of the Blaine Apparatus as delivered. The Manufacturer reserves the right to add supplementary information to this Operating Manual as required.

The guarantee provided by the Manufacturer is the legal guarantee. This guarantee does not cover wear-and-tear parts.

The Manufacturer guarantees trouble-free operation only if the User observes the instructions in this Operating Manual, and only if the User employs the Blaine Apparatus for the purpose for which it is intended.

The Manufacturer cannot be held liable for damages that may occur if the Blaine Apparatus is used for purposes for which it is not intended, or if the User does not observe the instructions and rules for operation as set forth in this Operating Manual.

No claims for damages may be lodged against the Manufacturer if the Blaine Apparatus is modified in its structural or constructional characteristics without the prior written consent of the Manufacturer, or if its functional characteristics are modified without such consent.

Any person acting in violation of the above stipulations may be prosecuted before a court of law.

## **1.5 Basic safety instructions**

Only those persons may be permitted to operate the Electronic Blaine Air-Permeability Apparatus alone (i.e., without supervision) who have met all of the following criteria:

- Persons who are at least eighteen (18) years of age, and
- Persons who have been instructed in the operation of the Blaine Apparatus, and

In the operation of the Blaine Apparatus, the person operating the instrument must take every precaution to ensure that he/she does not injure himself / herself or any other persons. Only those persons may be permitted to operate the Blaine Apparatus who have been instructed in its proper use.

If any malfunction, damage, or other trouble is determined on the Blaine Apparatus, and if its faulty condition endangers its operational safety, then the apparatus must be immediately taken out of operation. It may be put back into operation only after all sources of danger have been eliminated.

Check to make sure that the ratings given on the nameplate (rating plate) on the unit match those of the actual voltage supplied by the mains power.

The Blaine Apparatus may be used only for the purposes described here. Any use of the apparatus in a manner not intended or described here will result in loss of guarantee protection.

This Blaine Apparatus has been designed and built in accordance with the state of the engineering art and with the accepted rules of good engineering practice. The use of this Blaine Apparatus, however, can result in danger to life and limb of the Users and third parties, and can cause damage to mechanical-engineering parts and other items of property.

If there are any malfunctions or other trouble that could cause dangerous situations to arise in work with the Blaine Apparatus, these difficulties must be immediately corrected before working with the machine.

<p>Danger</p> 	<p>The mixing of cement with water causes the release of alkaline substances. In working with concrete, it is essential to take all necessary precautions to prevent dry cement from entering the eyes, mouth, or nose. Use protective clothing to prevent skin contact with wet cement or concrete. If cement or concrete enters the eyes, immediately and carefully wash out the eyes with clean water. Seek medical help without delay. If moist concrete comes into contact with the skin, wash it off immediately.</p>
	<p>The liquid in the manometer is, as recommended in the relevant standard. This liquid can cause serious health. Please read the attachments for further information.</p>

The manufacturer strongly recommends to carefully observe the following: all instructions and procedure descriptions given in this Operating Manual; all applicable safety directives, guidelines, and regulations; and all general rules for workplace environments.

The Operator must ensure that the personnel wear the respectively required protective clothing, such as:

Safety boots

Suitable clothing

Protective gloves

Working clothing must be appropriate and not hinder the operatives in their work.

If need respiratory protection

## 1.6 Acceptance of the product and transport

### 1.6.1 Acceptance of the product

When accepting delivery of the product, first inspect it for its outer, visible condition. If this inspection is satisfactory, the machine may be accepted from the freight forwarder (package service, courier, or other forwarding business).

If there are no shortcomings, and if there are no transport damages, then use the bill of delivery to make sure that the consignment is complete, and that all parts have been delivered.

If you assume or suspect transport damage, or if transport damage becomes apparent only after you have accepted the delivery, immediately make an exact report of the conditions and any damage as they exist. Send us this report immediately by fax or e-mail.

**Important:** Absolutely do not make any changes to the delivered goods.

After we have studied your report, we can make a decision whether we can correct the difficulties by one of the following options:

- Deliver spare parts to you, or
- Send a specialized fitter/installer to your plant, or
- Ask that you return the system to us for repair.

## 1.6.2 Transport

This device will be delivered in the appropriate cardboard boxes. In order to prevent transport damage, the remaining hollow spaces in the interior of the boxes will be filled with bulk material.

This system can be moved by hand to the point at which it is to be operated. Its weight is approx. 4 kg.

After you have unpacked the device, make a visual inspection to determine whether it was damaged during transport. In cases of doubt, in which you believe the machine may have been damaged, do not connect it, and get in touch with your dealer or sales person.

## 1.7 Scope of delivery

- 1 ea. Air Permeability Tester, including power cable, measuring cell with piston, and sieve plates
- 1 ea. Brush
- 1 ea. Funnel
- 50 ml Filling oil for manometer
- 1 ea. Cone grease
- 1 ea. Injection unit with hose for filling
- 1 unit Round filter,  $\varnothing$  12.8 mm
- 1 ea. Digital thermometer
- 1 ea. Cone rubber stopper
- Official calibration (only model 1.0290E)



Optional:

- 1 bottle Calibration sand, coarse
- 1 bottle Calibration sand, fine
- Official calibration

<p>Note</p> 	<p>When the Electronic Blaine Air-Permeability Apparatus is delivered, it is NOT calibrated. If the customer requires, we can deliver the instrument with official calibration: as an option, for an additional price. <b>Important:</b> do not place the Electronic Blaine Air-Permeability Apparatus into operation before it has been properly calibrated.</p>
---	---



## 1.8 Instructions for electrical connection

<p>Danger</p> 	<p>The electrical connections must be made by properly qualified electricians.</p> <p>Before making the power connections, make sure that your power supply is in accordance with the required power and frequency ratings given in these instructions and on the equipment rating plate.</p> <p>The power plug must have a safety device (an overcurrent trip) that protects the system against overcurrent. This device must match the machine voltage, and must be in accordance with the valid regulations. The technical characteristics of this safety device must satisfy the regulations of the standards that apply in the country in which the machine is being installed.</p>
<p>Caution</p> 	<p>The Manufacturer cannot be held liable for any damage that takes place because the above instructions are not followed.</p>

### Electrical tolerances:

Actual voltage:  $\pm 10\%$  of the rated voltage

Frequency:  $\pm 1\%$  of the rated frequency, on a continual basis;  $\pm 2\%$  of the rated frequency, on a short-term basis

The power supply may not be interrupted for longer than 3 ms, and may not be set to zero. Not more than 1 s may lapse between two power outages (cuts).

The power outages (cuts) may not exceed 20% of the voltage peak for more than one cycle. Not more than 1 s may elapse between two power cuts.

The manufacturer cannot be held liable for damages to persons or property that arise because the above instructions have not been observed.



## 2. Characteristics of the apparatus

### 2.1 Basic structural design

The measuring apparatus is mounted on a stable metal plate. A sturdy metal enclosure on the left side of the apparatus contains the U-shaped manometer tube. The User can observe the level of the manometer fluid through a window.

You can stop the testing procedure at any time by turning off the mains power switch. The power connection is provided by a separate power cable with a two-pole and earthing-pin plug.

The Manufacturer tests the function and liquid tightness of the apparatus before delivery.

### 2.2 Technical data

Power rating:	110-230 V / 50-60 Hz
Dimensions of the Apparatus:	175 mm wide x 300 mm deep x 450 mm high
Weight:	4 kg
Precision of the time measurement:	0.1 s

Cell size according EN 196-6  
 $V \approx 1900 \text{ mm}^3$   
 $\varnothing = 12,7 \text{ mm} \pm 1$   
 $H = 15 \text{ mm} \pm 1$

- 1- Opening to fill the manometer liquid
- 2- U- shaped tube
- 3- Measuring section with photoelectric barrier
- 4- Measuring cell with piston and sieve plates
- 5- Connection support
- 6- operators interface

Rear side:  
Power switch

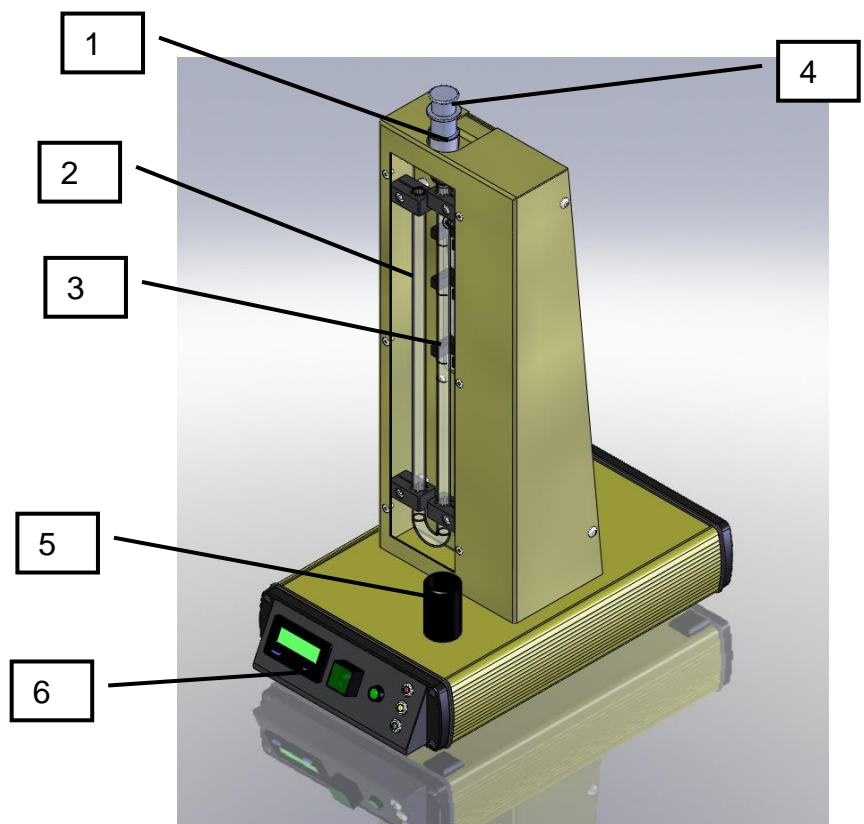

### 3. Placing the Apparatus into operation

<p>Note</p> 	<p>The Manufacturer cannot be held liable for damages that may occur if the User does not observe the instructions and rules for operation as set.</p> <p>No claims for damages may be lodged against the Manufacturer.</p>
---	---

Set up the Blaine Apparatus on a surface that is level, that is not subject to vibrations, and that can sufficiently support the weight of the apparatus. The permissible ambient conditions are in accordance with standard laboratory conditions as set forth in EN 196

Use the injection with hose, supplied by the Manufacturer, to pour the filling oil into the U-shaped tube. Before filling the tube, make sure that it is clean and dry.

Use the injection unit to remove liquid from the bottle in which it is delivered. Insert the end of the injector hose into the U-shaped tube. Make sure that you can see the hose in the U-shaped tube, and also make sure that the manometer liquid actually flows into the tube. Fill the liquid up to the lowest mark.

If the liquid is filled above the proper filling height, use the injector unit to remove the surplus oil.

Grease the cone slightly with the delivered grease.

<p>Caution</p> 	<p>The manometer liquid is a mineral hydraulic oil. This liquid can cause serious health.</p> <p>Do not pour out the oil throuht the cone. It could go to a valve and could cause damage.</p>
--	---

<p>Note</p> 	<p>Fill the oil slowly and carefully, since the levels of the oil will adjust very slowly.</p> <p>If exceed the mark then use the injection with tube to suck out the surplus oil.</p> <p>At regular intervals, the liquid level must be checked. The fluid level must be equal to the mark.</p>
---	--

<p>Note</p> 	<p>The ring markings of the U-tube are not centered to the light barriers.</p> <p>They would otherwise interfere with the laser of the light barriers.</p> <p>The distances of the light barriers comply with the EN196-6 standard.</p>
---	---

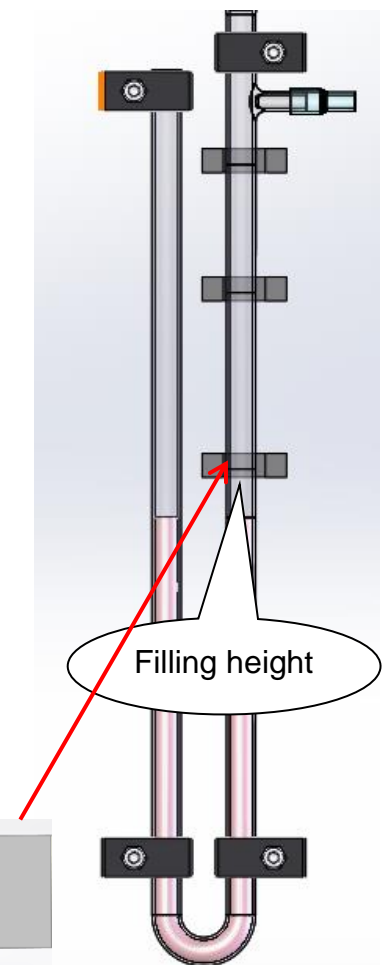
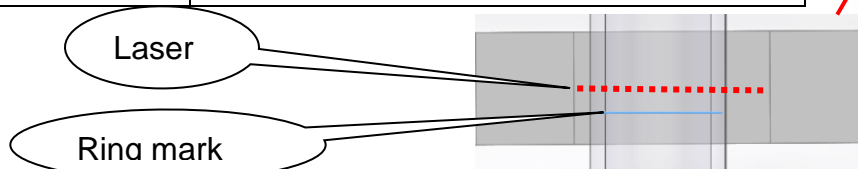

### 3.1 Pump performance

The suction of the manometer liquid can be determined by the pump capacity. It is preset in the factory.

After initial commissioning / initial filling, after a change of liquid and during the entire operating period, the behaviour must be checked.

Two situations are to be avoided:

1. During the step of suction of the manometer liquid, do not allow the liquid to be pulled through the U-bend.

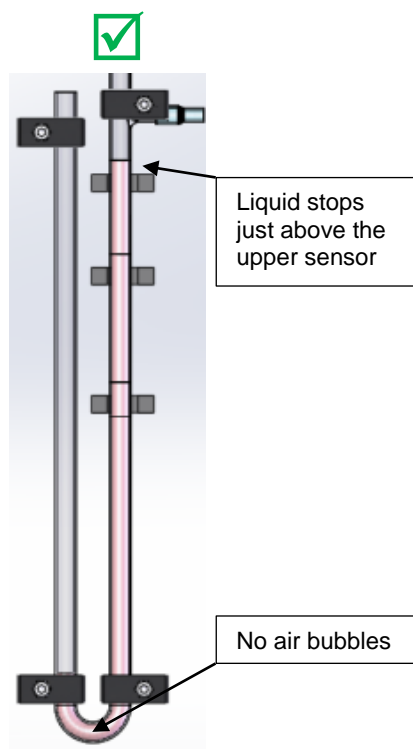

perfect setting

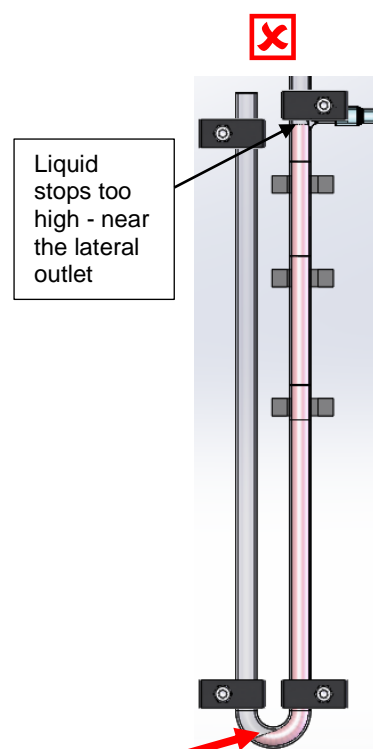

This can have several causes:

- the pump power is set too strong
- Too less liquid in the U-tube
- Incorrectly adjusted sensors

2. The liquid must not get into the lateral outlet.

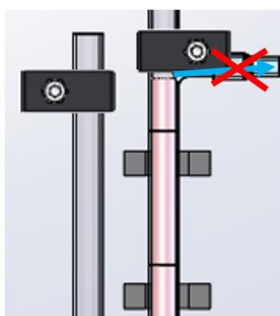

The main cause is a too strong set value for pump power.

Caution



If fluid go to valve and pump then it causes damage.

Procedure for verification:

Remove the measuring cell from the glass cone. Start the device. The pump starts to work. Then the glass cone is slowly sealed with the finger or thumb or with the palm of the hand. The liquid begins to rise upwards. The velocity of the liquid must be slow (slightly jerky) and the liquid must remain at the upper mark of the U-tube.

If the liquid level remains standing or is it too quick, open the rear sheet plate and adjust the potentiometer and/or the throttle valve.

See chapter Troubleshooting

#### 4. How to conduct the test

- 1 Prepare the powder bed in accordance with the instructions given in DIN 196-6.
- 2 Place a thin coat of cone grease on the cone. Then insert the measuring cell into the opening of the U-shaped tube that is provided for the cell.
- 3 Be careful not to disturb the powder bed in your work.
- 4 Switch the device on by using the power switch on the rear side. The green READY lamp will now show.
- 5 Now briefly press the START button. (do not hold)

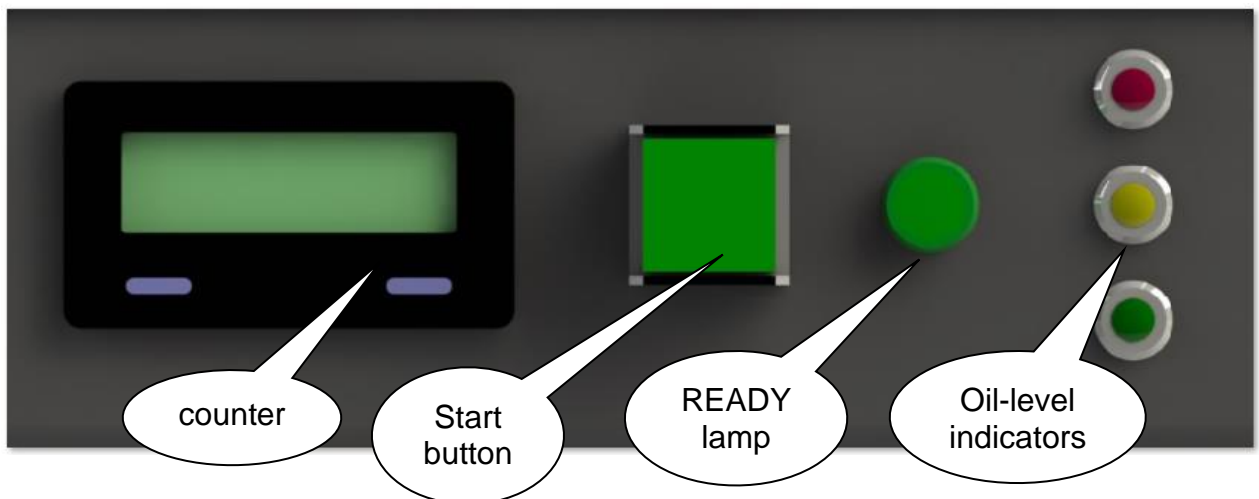

The system will now pull in the oil.

- The lamps of the fluid-level indicators will now show consecutively: green, amber, and red.
- The READY lamp will now go off.
- The red lamp will now show, which means that the digital counter is set to zero.
- The pump stops, and the solenoid valve closes.
- The oil level now falls slowly.
- As soon as the amber lamp goes off, the time measurement will begin.
- When the green oil-level lamp goes off, the time measurement will stop.
- The READY lamp will then go back on.

- The clock will show the measured time, which is given in one-hundredths 1/100 of a second.

Make a note of this time and of the room temperature, with a precision of  $\pm 1^\circ\text{C}$  for the temperature.

Now repeat the above procedure, in accordance with Section 4.6.2 of the standard EN 196-6

## 5. Checking and maintenance

In case of special maintenance work (e.g., repairs, exchange of parts, and all other work that is not described in this Operating Manual), please get directly in touch with the manufacturer.

The Blaine Apparatus requires practically no maintenance. After long service, we recommend a thorough cleaning and refilling of the U-shaped tube with the required liquid.

If the apparatus has been used for a long time, or if the ambient conditions make an external cleaning of the apparatus necessary, please proceed as follows:

- Switch off the main power switch on the reverse of the apparatus.
- Disconnect the apparatus from the power supply.
- Use a brush or vacuum cleaner to remove loose dust on the apparatus. If necessary, the apparatus can then be cleaned with a moist cloth. Use a normal household cleaning agent for this purpose.

<p>Caution</p> 	<p>Do <b>NOT</b> try to clean the apparatus with pressurized water, water or other liquid spray, spray water that results in puddles, dripping sponges, or any other unsuitable cleaning methods. If any of these methods are used, the water or other liquid that results can enter the control system and lead to permanent damages to the mechanical, electrical, and/or electronic components of the apparatus.</p>
--	---



All maintenance work involving components of the apparatus and/or the electrical system must be conducted by qualified specialists.

At regular intervals, the liquid level must be checked. The fluid level must be equal to the mark.

The glass cone should be lightly greased.

## 6. Troubleshooting

This section describes a number of simple problems tht can be easily solved during work.

<p>Caution</p> 	<p>All maintenance, inspection, testing, and repair work on apparatus components or on the electrical system may be performed <b>ONLY</b> by sufficiently qualified personnel.</p>	
PROBLEM	CAUSE	SOLUTION
<p>The system will not start.</p>	<p>There is no power to the system.</p>	<p>Operate the main power switch correctly, check the power cable, fuse on the main switch and exchange it if necessary.</p>
	<p>The pump or the electrical system is defective.</p>	<p>Get in touch with the Supplier.</p>
	<p>The U-shaped tube is covered with condensation or dirt.</p>	<p>Clean the U-shaped tube.</p>
<p>The manometer fluid is not pulled in correctly.</p>	<p>pump, valve is defective The pneumatic lines are loose or have leaks.</p>	<p>Get in touch with the Supplier.</p>
	<p>The U-shaped tube is covered with condensation or dirt.</p>	<p>Clean the U-shaped tube.</p>
<p>The measured values are not correct.</p>	<p>The constant for the apparatus is not correct.</p>	<p>Correctly determine the constant for the system.</p>
	<p>The calibration substance does not properly match the cement type.</p>	<p>Choose the proper calibration substance to correctly match the cement type.</p>
	<p>The time metering is not correct. The photoelectric barrier does not function.</p>	<p>Regulate the photoelectric barriers on the potentiometer. Check the time metering. Clean the U-shaped tube.</p>
	<p>The measuring cell has not been properly attached, or it has not been turned correctly. There is a leak in the connection between the fittings.</p>	<p>Check the glass cone</p>
<p>Note</p> 	<p>If the device is to be sent for repair, the manometer liquid must be sucked off in order to avoid further damages to the device.</p>	

In case of any malfunction, be sure to disconnect the Electronic Blaine Air-Permeability Apparatus from the electric power supply.

### Trouble

The READY lamp does not burn after the Electronic Blaine Air-Permeability Apparatus is switched on.

The apparatus pulls / doesn't pull in the filling oil too fast, or too slow.

### Solution to the problem

Check the fuse on the mains switch.

Open the rear cover of the manometer column and adjust both together the throttle valve and the potentiometer

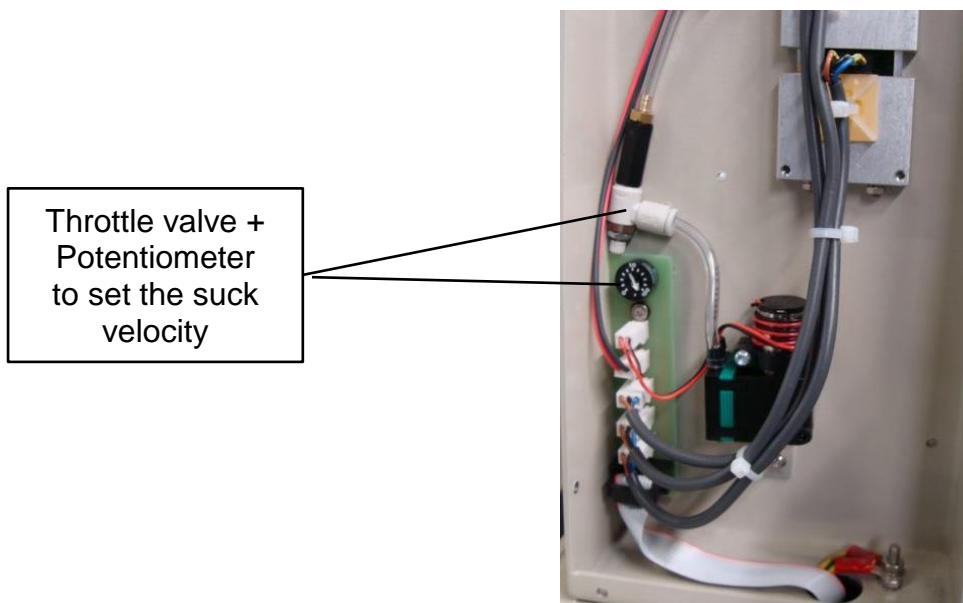

## 7. Shutting down the system for lengthy periods

If the Blaine Apparatus is scheduled to remain out of operation for a lengthy period of time, please follow these steps:

- Disconnect the apparatus from the power supply.
- Perform all required maintenance work.
- Remove the liquid from the U-shaped tube.
- Then cover the apparatus to protect it from dust

## 8. Scrapping

If the apparatus will not be used again, we recommend the following steps for scrapping:

- Disconnect the power cable from the power supply.
- Cover all sharp, protruding, or otherwise dangerous parts.
- Disassemble the apparatus and scrap it in accordance with currently valid regulations.



## 9. Spare parts and services

A great deal of care has been taken to ensure that this Operating Manual is correct. We cannot, however, guarantee that it is without mistakes or errors, or that all information contained herein will continue to remain valid in the event of technical changes.

### 9.1 Date of issue of this Operating Manual:

Version no. 15  
Aug. 2021

### 9.2 Copyright

The copyright to this Operating Manual is held by the following company:

**TESTING** Bluhm & Feuerherdt GmbH

This Operating Manual is provided only for the using company, and the staff of this company. The information in this Operating Manual may not be:

- Reproduced, or
- Distributed, or
- Provided to any other persons.

Any person acting in violation of the above stipulations may be prosecuted before a court of law.

### 9.3 Address for technical support and spare-parts ordering

If you have any technical questions, or if you require spare parts, please get directly in touch with the following address:

**TESTING Bluhm & Feuerherdt GmbH**  
Motzener Str. 26b  
DE – 12277 Berlin  
Germany  
Tel.: +49 30 (0) 7109645-0  
Fax: +49 30 (0) 7109645-98  
E-mail: [info@testing.de](mailto:info@testing.de)  
[www.testing.de](http://www.testing.de)

## 10. Spare-Parts List

<b>Order number:</b>	<b>Designation of spare parts:</b>	<b>Pack size:</b>
1.0209.01	Official calibration performed by the Manufacturer (a service at extra cost)	1
1.0209.02	Calibration sand (coarse)	1
1.0209.03	Calibration sand (fine)	1
1.0209.09	Filter paper, 12.8 mm diameter	1000
1.0209.05	Filling oil, 50 ml	1
1.0290.02	U-shaped tube	1
1.0209-08	Cone grease	1
1.0209-20	Measuring cell	1
1.0209-22	Funnel	1
1.0209-24	Brush	1
1.0290-25	Power cable	
1.0209-26	Digital thermometer	1

**EC Declaration of Conformity in accordance with the Machinery Directive  
2006/42/EC Appendix II 1.A**

The authorised representative established in the community,

Mr. Feuerherdt

hereby declares that the following product

Manufacturer: TESTING Bluhm & Feuerherdt GmbH  
Motzener Str. 26b  
12277 Berlin  
Product designation: 1.0290/1.0290E  
Serial number: continuous  
Serial/Type designation: electr. Blaine Apparatus

complies with all of the relevant provisions of the above named guidelines as well as the additional applied guidelines (following) - including any of the amendments thereto which are in force at the time of the declaration.

The following additional EU Directives have been applied:

Low Voltage Directive 2014/35/EC

The following harmonised standards have been applied:

DIN EN 60204-1 The Safety of Machines - Electrical Equipment of Machines - Part 1:  
General Requirements  
DIN EN ISO 12100 Safety of machinery - General principles for design - Risk assess-  
ment and risk reduction (corrigendum 2013)

The name and address of the person who has been authorised to compile the technical documentation: Mr. Metge

Location: Berlin

Date: 28/01/2014

A handwritten signature in blue ink, appearing to read 'Feuerherdt'.

(Signature)  
Managing Director

A handwritten signature in blue ink, appearing to read 'S. Metge'.

(Signature)  
Technician

Material Safety Data Sheet

**1. IDENTIFICATION OF THE SUBSTANCE/PREPARATION AND COMPANY/UNDERTAKING**

**Material Name :** Shell Tellus S2 V 15  
**Uses :** Hydraulic oil  
**Product Code :** 001D7747  
**Manufacturer/Supplier :** PT Shell Indonesia  
Talavera Office Park  
22nd-27th Floor  
22-26 Jl. Letjen TB Simatupang Kav.  
Jakarta Selatan 12430  
Indonesia  
**Telephone :** (+62) 2175924700  
**Fax :** (+62) 2175924679  
**Emergency Telephone Number :** (+62) 811 984 290

**2. COMPOSITION/INFORMATION ON INGREDIENTS**

**Preparation Description :** Highly refined mineral oils and additives.  
**Additional Information :** The highly refined mineral oil contains <3% (w/w) DMSO extract, according to IP346.

**3. HAZARDS IDENTIFICATION**

**EC Classification :**  
**Health Hazards :**

Not classified as dangerous under EC criteria.  
Not expected to be a health hazard when used under normal conditions. Prolonged or repeated skin contact without proper cleaning can clog the pores of the skin resulting in disorders such as oil acne/folliculitis. Aspiration into the lungs when swallowed or vomited may cause chemical pneumonitis which can be fatal. High-pressure injection under the skin may cause serious damage including local necrosis. Used oil may contain harmful impurities.

**Signs and Symptoms :**

If material enters lungs, signs and symptoms may include coughing, choking, wheezing, difficulty in breathing, chest congestion, shortness of breath, and/or fever. The onset of respiratory symptoms may be delayed for several hours after exposure. Local necrosis is evidenced by delayed onset of pain and tissue damage a few hours following injection. Oil acne/folliculitis signs and symptoms may include formation of black pustules and spots on the skin of exposed areas. Ingestion may result in nausea, vomiting and/or diarrhoea.

**Safety Hazards :**  
**Environmental Hazards :**

Not classified as flammable but will burn.  
Not classified as dangerous for the environment.

**4. FIRST AID MEASURES**

**Inhalation :**  
**Skin Contact :**

No treatment necessary under normal conditions of use. If symptoms persist, obtain medical advice.  
Remove contaminated clothing. Flush exposed area with water and follow by washing with soap if available. If persistent irritation occurs, obtain medical attention. When using high pressure equipment, injection of product under the skin can occur. If high pressure injuries occur, the casualty should be sent immediately to a hospital. Do not wait for symptoms to develop. Obtain medical attention even in the absence of apparent wounds.

**Eye Contact :**  
**Ingestion :**

Flush eye with copious quantities of water. If persistent irritation occurs, obtain medical attention.  
If swallowed, do not induce vomiting; transport to nearest medical facility for additional treatment. If vomiting occurs spontaneously, keep head below hips to prevent aspiration. If any of the following delayed signs and symptoms appear within the next 6 hours, transport to the nearest medical facility: fever greater than 101° F (37° C), shortness of breath, chest congestion or continued coughing or wheezing.

**Advice to Physician :**

Treat symptomatically. Potential for chemical pneumonitis. Consider: gastric lavage with protected airway, administration of activated charcoal. High pressure injection injuries require prompt surgical intervention and possibly steroid therapy, to minimise tissue damage and loss of function. Because entry wounds are small and do not reflect the seriousness of the underlying damage, surgical exploration to determine the extent of involvement may be necessary. Local anaesthetics or hot soaks should be avoided because they can contribute to swelling, vasospasm and ischaemia. Prompt surgical decompression, debridement and evacuation of foreign material should be performed under general anaesthetics, and wide exploration is essential. Call a doctor or poison control center for guidance.

**5. FIRE FIGHTING MEASURES**

Clear fire area of all non-emergency personnel.

**Specific Hazards :**

Hazardous combustion products may include: A complex mixture of airborne solid and liquid particulates and gases (smoke). Carbon monoxide. Unidentified organic and inorganic compounds.

**Suitable Extinguishing Media:**

Foam, water spray or fog. Dry chemical powder, carbon dioxide, sand or earth may be used for small fires only.

**Unsuitable Extinguishing Media:**

Do not use water in a jet.

**Protective Equipment for Firefighters**

Proper protective equipment including breathing apparatus must be worn when approaching a fire in a confined space.

**6. ACCIDENTAL RELEASE MEASURES**

Avoid contact with spilled or released material. For guidance on selection of personal protective equipment see Chapter 8 of this Material Safety Data Sheet. See Chapter 13 for information on disposal. Observe the relevant local and international regulations.

**Protective measures :**

Avoid contact with skin and eyes. Use appropriate containment to avoid environmental contamination. Prevent from spreading or entering drains, ditches or rivers by using sand, earth, or other appropriate barriers.

**Clean Up Methods :**

Slippery when spilt. Avoid accidents, clean up immediately. Prevent from spreading by making a barrier with sand, earth or other containment material. Reclaim liquid directly or in an absorbent. Soak up residue with an absorbent such as clay, sand or other suitable material and dispose of properly.

**Additional Advice :**

Local authorities should be advised if significant spillages cannot be contained.

**7. HANDLING AND STORAGE**

**General Precautions :**

Use local exhaust ventilation if there is risk of inhalation of vapours, mists or aerosols. Properly dispose of any contaminated rags or cleaning materials in order to prevent fires. Use the information in this data

sheet as input to a risk assessment of local circumstances to help determine appropriate controls for safe handling, storage and disposal of this material.

**Handling :** Avoid prolonged or repeated contact with skin. Avoid inhaling vapour and/or mists. When handling product in drums, safety footwear should be worn and proper handling equipment should be used.

**Storage :** Keep container tightly closed and in a cool, well-ventilated place. Use properly labelled and closeable containers. Storage Temperature: 0 - 50 °C / 32 - 122 °F

**Recommended Materials :** For containers or container linings, use mild steel or high density polyethylene.

**Unsuitable Materials :** PVC.

**Additional Information :** Polyethylene containers should not be exposed to high temperatures because of possible risk of distortion.

## 8. EXPOSURE CONTROLS/PERSONAL PROTECTION

If the American Conference of Governmental Industrial Hygienists (ACGIH) value is provided on this document, it is provided for information only.

### Occupational Exposure Limits

Material	Source	Type	ppm	mg/m3	Notation
Oil mist, mineral	ACGIH	TWA [Mist.]		5 mg/m3	
	ACGIH	STEL [Mist.]		10 mg/m3	
	ID OEL	NAB [Mist.]		5 mg/m3	

### Biological Exposure Index (BEI) - See reference for full details

Data not available

**Exposure Controls :** The level of protection and types of controls necessary will vary depending upon potential exposure conditions. Select controls based on a risk assessment of local circumstances. Appropriate measures include: Adequate ventilation to control airborne concentrations. Where material is heated, sprayed or mist formed, there is greater potential for airborne concentrations to be generated.

**Personal Protective Equipment:** Personal protective equipment (PPE) should meet recommended national standards. Check with PPE suppliers.

**Respiratory Protection :** No respiratory protection is ordinarily required under normal conditions of use. In accordance with good industrial hygiene practices, precautions should be taken to avoid breathing of material. If engineering controls do not maintain airborne concentrations to a level which is adequate to protect worker health, select respiratory protection equipment suitable for the specific conditions of use and meeting relevant legislation. Check with respiratory protective equipment suppliers. Where air-filtering respirators are suitable, select an appropriate combination of mask and filter. Select a filter suitable for combined particulate/organic gases and vapours [boiling point>65°C(149 °F)].

**Hand Protection :** Where hand contact with the product may occur the use of gloves approved to relevant standards (e.g. Europe: EN374, US: F739) made from the following materials may provide suitable chemical protection: PVC, neoprene or nitrile rubber gloves. Suitability and durability of a glove is dependent on usage, e.g. frequency and duration of contact, chemical resistance of glove material, glove thickness, dexterity. Always seek advice from glove suppliers. Contaminated gloves should be replaced. Personal hygiene is a key element of effective hand care. Gloves must only be worn on clean hands. After using gloves, hands should be washed and dried thoroughly. Application of a non-perfumed moisturizer is recommended.

**Eye Protection :** Wear safety glasses or full face shield if splashes are likely to occur.

**Protective Clothing :** Skin protection is not required under normal conditions of use. It is good practice to wear chemical resistant gloves.

**Monitoring Methods :** Monitoring of the concentration of substances in the breathing zone of workers or in the general workplace may be required to confirm compliance with an OEL and adequacy of exposure controls. For some substances biological monitoring may also be appropriate.

**Environmental Exposure Controls:** Minimise release to the environment. An environmental assessment must be made to ensure compliance with local environmental legislation.

## 9. PHYSICAL AND CHEMICAL PROPERTIES

**Appearance :** Amber. Liquid at room temperature.

**Odour :** Slight hydrocarbon.

**pH :** Not applicable.

**Initial Boiling Point and :> 280 °C / 536 °F estimated value(s)**

**Boiling Range**

**Pour point :** Typical -42 °C / -44 °F

**Flash point :** Typical 170 °C / 338 °F (COC)

**Upper / lower Flammability or Explosion limits:Typical 1 - 10 %(V) (based on mineral oil)**

**Auto-ignition temperature :** > 320 °C / 608 °F

**Vapour pressure :** < 0.5 Pa at 20 °C / 68 °F (estimated value(s))

**Specific gravity :** Typical 0.872 at 15 °C / 59 °F

**Density :** Typical 872 kg/m3 at 15 °C / 59 °F

**Water solubility :** Negligible.

**Solubility in other solvents :** Data not available

**n-octanol/water partition coefficient (log Pow) > 6 (based on information on similar products)**

**Dynamic viscosity :** Data not available

**Kinematic viscosity :** Typical 15 mm2/s at 40 °C / 104 °F

**Vapour density (air=1) :** > 1 (estimated value(s))

**Evaporation rate (nBuAc=1) :** Data not available

**Decomposition Temperature:** Data not available

## 10. STABILITY AND REACTIVITY

**Stability :** Stable.

**Conditions to Avoid :** Extremes of temperature and direct sunlight.

**Materials to Avoid :** Strong oxidising agents.

**Hazardous Decomposition Products** Hazardous decomposition products are not expected to form during normal storage.

#### 11. TOXICOLOGICAL INFORMATION

<b>Basis for Assessment :</b>	Information given is based on data on the components and the toxicology of similar products.
<b>Acute Oral Toxicity :</b>	Expected to be of low toxicity: LD50 > 5000 mg/kg , Rat Aspiration into the lungs may cause chemical pneumonitis which can be fatal.
<b>Acute Dermal Toxicity :</b>	Expected to be of low toxicity: LD50 > 5000 mg/kg , Rabbit
<b>Acute Inhalation Toxicity :</b>	Not considered to be an inhalation hazard under normal conditions of use.
<b>Skin Irritation :</b>	Expected to be slightly irritating. Prolonged or repeated skin contact without proper cleaning can clog the pores of the skin resulting in disorders such as oil acne/folliculitis.
<b>Eye Irritation :</b>	Expected to be slightly irritating.
<b>Respiratory Irritation :</b>	Inhalation of vapours or mists may cause irritation.
<b>Sensitisation :</b>	Not expected to be a skin sensitiser.
<b>Repeated Dose Toxicity :</b>	Not expected to be a hazard.
<b>Mutagenicity :</b>	Not considered a mutagenic hazard.
<b>Carcinogenicity :</b>	Product contains mineral oils of types shown to be oncogenic in animal skin-painting studies. Highly refined mineral oils are not classified as carcinogenic by the International Agency for Research on Cancer (IARC). Other components are not known to be associated with carcinogenic effects.
<b>Reproductive and Developmental Toxicity</b>	Not expected to be a hazard.
<b>Additional Information :</b>	Used oils may contain harmful impurities that have accumulated during use. The concentration of such impurities will depend on use and they may present risks to health and the environment on disposal. ALL used oil should be handled with caution and skin contact avoided as far as possible. High pressure injection of product into the skin may lead to local necrosis if the product is not surgically removed.

#### 12. ECOLOGICAL INFORMATION

Ecotoxicological data have not been determined specifically for this product. Information given is based on a knowledge of the components and the ecotoxicology of similar products.

<b>Acute Toxicity :</b>	Poorly soluble mixture. May cause physical fouling of aquatic organisms. Expected to be practically non toxic: LL/EL/IL50 > 100 mg/l (to aquatic organisms) (LL/EL50 expressed as the nominal amount of product required to prepare aqueous test extract). Mineral oil is not expected to cause any chronic effects to aquatic organisms at concentrations less than 1 mg/l.
<b>Microorganisms :</b>	Data not available
<b>Mobility :</b>	Liquid under most environmental conditions. Floats on water. If it enters soil, it will adsorb to soil particles and will not be mobile.
<b>Persistence/degradability :</b>	Expected to be not readily biodegradable. Major constituents are expected to be inherently biodegradable, but the product contains components that may persist in the environment.
<b>Bioaccumulation :</b>	Contains components with the potential to bioaccumulate.
<b>Other Adverse Effects :</b>	Product is a mixture of non-volatile components, which are not expected to be released to air in any significant quantities. Not expected to have ozone depletion potential, photochemical ozone creation potential or global warming potential.

#### 13. DISPOSAL CONSIDERATIONS

<b>Material Disposal :</b>	Recover or recycle if possible. It is the responsibility of the waste generator to determine the toxicity and physical properties of the material generated to determine the proper waste classification and disposal methods in compliance with applicable regulations. Do not dispose into the environment, in drains or in water courses.
<b>Container Disposal :</b>	Dispose in accordance with prevailing regulations, preferably to a recognised collector or contractor. The competence of the collector or contractor should be established beforehand.
<b>Local Legislation :</b>	Disposal should be in accordance with applicable regional, national, and local laws and regulations.

#### 14. TRANSPORT INFORMATION

Land (as per ADR classification): Not regulated

<b>IMDG</b>	This material is not classified as dangerous under ADR regulations.
<b>IATA (Country variations may apply)</b>	This material is not classified as dangerous under IMDG regulations. This material is not classified as dangerous under IATA regulations.

#### 15. REGULATORY INFORMATION

The regulatory information is not intended to be comprehensive. Other regulations may apply to this material.

<b>EC Classification :</b>	Not classified as dangerous under EC criteria.
<b>EC Symbols :</b>	No Hazard Symbol required
<b>EC Risk Phrases :</b>	Not classified.
<b>EC Safety Phrases :</b>	Not classified.

#### Chemical Inventory Status

<b>EINECS :</b>	All components listed or polymer exempt.
<b>TSCA :</b>	All components listed.

#### 16. OTHER INFORMATION

<b>R-phrases(s)</b>	Not classified.
<b>MSDS Version Number :</b>	1.0
<b>MSDS Effective Date :</b>	15.10.2010
<b>MSDS Revisions :</b>	A vertical bar ( ) in the left margin indicates an amendment from the previous version.
<b>MSDS Distribution :</b>	The information in this document should be made available to all who may handle the product.
<b>Disclaimer :</b>	This information is based on our current knowledge and is intended to describe the product for the purposes of health, safety and environmental requirements only. It should not therefore be construed as guaranteeing any specific property of the product.